



Table for standard stroke

Tube I.D.	Stroke (mm)	Max. stroke (mm)
ø20	25,50,75,100,125,	300
ø25,32,40	150,200,250,300	

* Intermediate stroke are available, please contact us.

Tightening torque

Tube I.D.	Rod thread	Tightening torque (kgf·cm)
ø20	M8×1.25	100
ø25,32	M10×1.25	190
ø40	M14×1.5	540

* Make sure the tightening torque of rod thread does not exceed the value above.

* The tolerance of tightening torque is ±5%.

Features

■ Non lubrication

- Special housing and bushing enables self lubrication of piston rod.

■ High quality long service life

- Cylinder with hexagonal rod design enables non-rotation of rod.
- Hard anodised stainless steel cylinder tubes offer a high resistance to corrosion and low internal friction.
- Cylinder mountings, available with a comprehensive range of accessories for rigid or flexible mounting.
- Magnetic as standard

Specification

Model	MCKMB				
Tube I.D. (mm)	20	25	32	40	
Port size	Rc1/8			Rc1/4	
Medium	Air				
Operating pressure range	0.05~0.7 MPa				
Proof pressure	1 MPa				
Lubricator	Not required				
Ambient temperature	-5~+60°C (No freezing)				
Available speed range	50~750 mm/sec				
Max. allowable kinetic energy (J)	Cushion pad	0.27	0.4	0.65	1.2
	Cushion air	0.54	0.78	1.27	2.35
Rod non-rotating accuracy	±0.7°		±0.5°		
Allowable rotational torque	2.0 kgf·cm	2.5 kgf·cm	2.5 kgf·cm	4.5 kgf·cm	
Sensor switch	RCM (Please refer to page 8-16)				
Sensor switch band	BM20	BM25	BM32	BM40	

* The cylinder is allowed little leakage. Before the cylinder is sale, it has passed the standard of leakage test.

* For precautions, please refer to page 3-2.

Order example

MCKMB – 11 – 40 – 50 – A – N – G

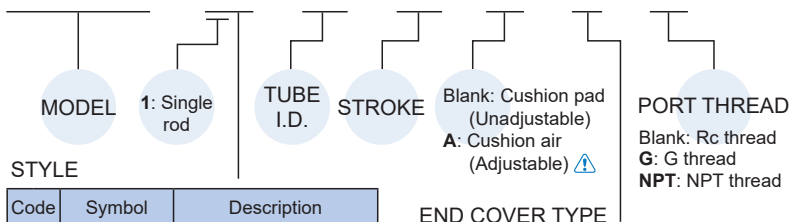

STYLE

Code	Symbol	Description
1 1		Double acting / Male thread

* Order example for special specification, refer to page 0-7.

END COVER TYPE

Code	Symbol	Description
Blank		Standard type
N		End-plain
E		With pivot type

⚠️ Caution





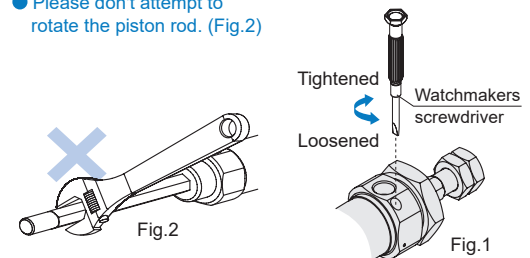

- For (A) Cushion air (Adjustable) (Fig.1)







1. To adjust a cushion needle, please slowly turn the needle valve from the fully closed status to the required status which needs to be within 2.5 turns.
2. If the needle valve loosen excessively, the buffer doesn't take effect and the lifetime of cylinder would be shortened.

- Please don't attempt to rotate the piston rod. (Fig.2)





Accessories & Connector

Accessories						
Code	LB (LB×2, with cover nut ×1)	LB (LB×1, without cover nut)	NUT		CA	CB
Cover type	Standrad type	End-plain (N) With pivot type (E)	-		Standrad type	
Mounting Tube I.D.			Rod nut 	Cover nut 		
ø20	LB-M2-20x2	LB-M2-20	NUT-M8x1.25x5Hx13B	NUT-M20x1.5x8Hx26B	CA-M2-20	CB-M2-20
ø25	LB-M2-25x2	LB-M2-25	NUT-M10x1.25x6Hx17B	NUT-M26x1.5x8Hx32B	CA-M2-25	CB-M2-25
ø32						
ø40	LB-M2-40x2	LB-M2-40	NUT-M14x1.5x8Hx22B	NUT-M32x2.0x10Hx41B	CA-M2-40	CB-M2-40

Accessories					Connector		
Code	FA	FB	SDB (with pin×1 + snap ring×2)	TA	TB	Y	I
Cover type	All applicable	Standard type	With pivot type (E)	All applicable	Standard type	All applicable	
Mounting Tube I.D.							
ø20	FA-M2-20		SDB-M2-20	TA-M2-20		Y-M2-20	I-M2-20
ø25	FA-M2-25			TA-M2-25		Y-M2-25	I-M2-25
ø32	FA-M2-25		SDB-M2-32	TA-M2-25		Y-M2-25	I-M2-25
ø40	FA-M2-40			TA-M2-40		Y-Q1-40	I-M2-40

Pin

Applicable	Y&I connector	CA&CB accessories	SDB accessories
Code	PIN-Y-P (with split pin / snap ring)	PIN-CB-P (with split pin / snap ring)	PIN-SDB (with split pin)
Fig Tube I.D.	 ø20~ø32 ø40	 ø20~ø32 ø40	
ø20	PIN-M2-20-1-P	PIN-M2-20-1-P	PIN-M2-20-2-P
ø25			
ø32	PIN-M2-40-2-P	PIN-M2-40-1-P	PIN-M2-32-1-P
ø40			

Cushion pad Unadjustable

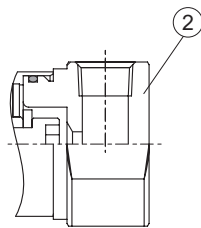
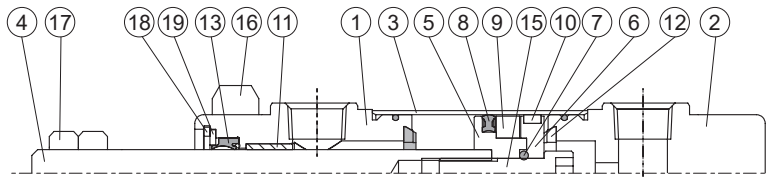

N type

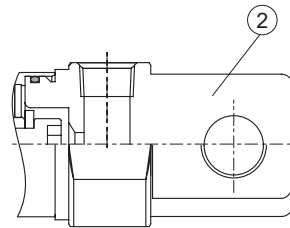

E type

Order example Component parts

Tube I.D.	Cushion pad
ø20	CP-MCKMB-20
ø25	CP-MCKMB-25
ø32	CP-MCKMB-32
ø40	CP-MCKMB-40

Tube I.D.	Cushion air
ø20	CP-MCKMB-20A
ø25	CP-MCKMB-25A
ø32	CP-MCKMB-32A
ø40	CP-MCKMB-40A

Cushion air Adjustable

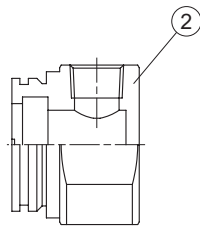
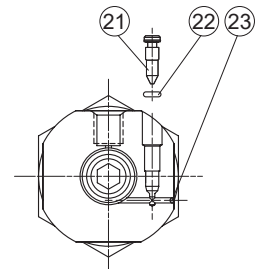
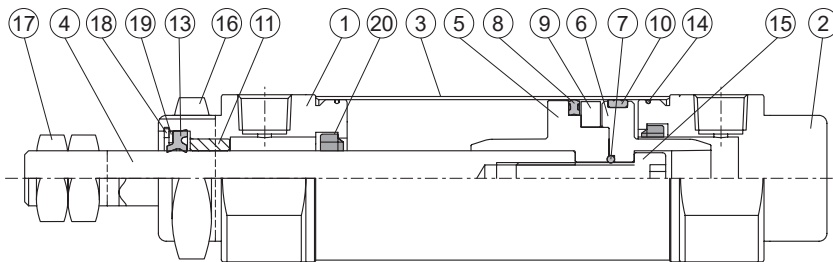

N type

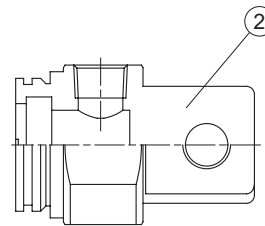

E type

Material

* CP: Component parts (inclusion)

No.	Cushion		Part name	Material	Q'y	CP *	
	Pad	Air				Pad	Air
1	●	●	Rod cover	Aluminum alloy	1	●	●
2	●	●	Head cover	Aluminum alloy	1	●	●
3	●	●	Tube	Stainless steel	1		
4	●	●	Piston rod	Stainless steel	1		
5	●	●	Piston-R	Aluminum alloy	1	●	●
6	●	●	Piston-H	Aluminum alloy	1	●	●
7	●	●	Piston gasket	NBR	1	●	●
8	●	●	Piston packing	NBR	1	●	●
9	●	●	Magnet ring	Magnet material	1	●	●
10	●	●	Wear ring	Resin	1	●	●
11	●	●	Rod bush	Bearing alloy	1	●	●
12	●		Cushion gasket	NBR	2	●	

No.	Cushion		Part name	Material	Q'y	CP *	
	Pad	Air				Pad	Air
13	●	●	Rod packing	NBR	1	●	●
14	●	●	Cover ring *1	NBR	2	●	●
15	●	●	Piston bolt	SCM	1	●	●
16	●	●	Tie nut	Carbon steel	1	●	●
17	●	●	Rod front nut	Carbon steel	2	●	●
18	●	●	Snap ring	Spring steel	1	●	●
19	●	●	Washer	Carbon steel	1	●	●
20		●	Cushion packing	NBR	2		●
21		●	Needle valve packing	NBR	2		●
22		●	Needle valve	Carbon steel	2		●
23		●	Steel ball	Stainless steel	2		●

*1. ø20, ø25 without this part.

MINIATURE CYLINDER WITH NON-ROTATING ROD

11

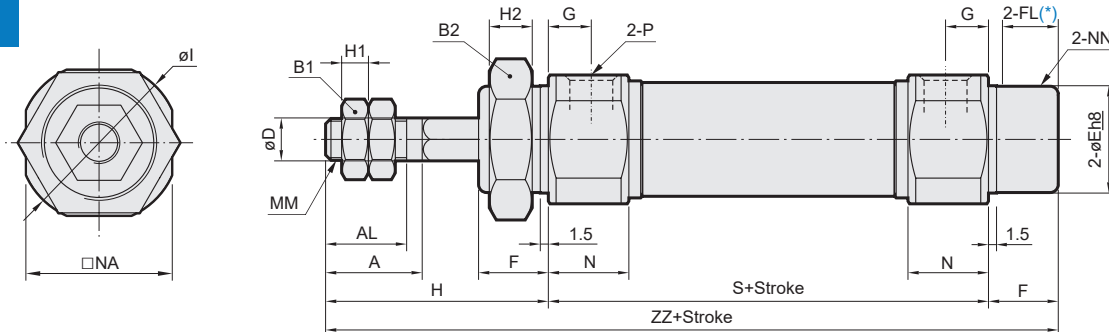

* FL: Effective thread length

Unit: mm

Code Tube I.D.	A	AL	B1	B2	D	E	F	FL	G	H	H1	H2	I	MM	N	NA	NN	P	S	ZZ
20	18	15.5	13	26	8	20 ⁰ _{-0.03}	13	10.5	8	41	5	8	28	M8×1.25	15	24	M20×1.5	Rc1/8	62	116
25	22	19.5	17	32	10	26 ⁰ _{-0.03}	13	10.5	8	45	6	8	33.5	M10×1.25	15	30	M26×1.5	Rc1/8	62	120
32	22	19.5	17	32	12	26 ⁰ _{-0.03}	13	10.5	8	45	6	8	37.5	M10×1.25	15	34.5	M26×1.5	Rc1/8	64	122
40	24	21	22	41	14	32 ⁰ _{-0.04}	16	13.5	11	50	8	10	46.5	M14×1.5	21.5	42.5	M32×2.0	Rc1/4	88	154

N

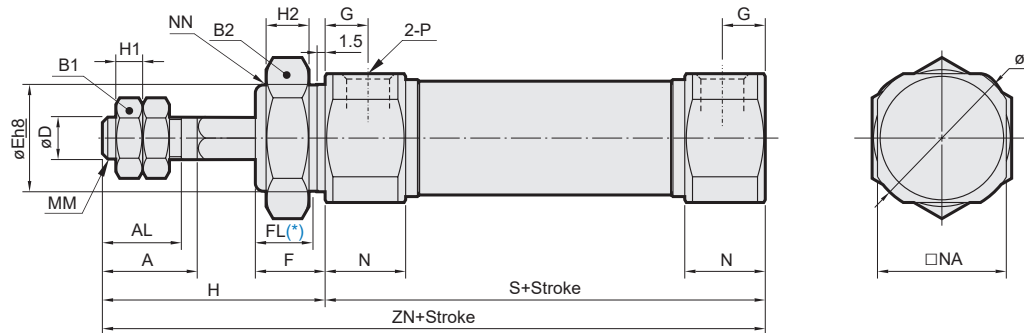

* FL: Effective thread length

Unit: mm

Code Tube I.D.	A	AL	B1	B2	D	E	F	FL	G	H	H1	H2	I	MM	N	NA	NN	P	S	ZN
20	18	15.5	13	26	8	20 ⁰ _{-0.03}	13	10.5	8	41	5	8	28	M8×1.25	15	24	M20×1.5	Rc1/8	62	103
25	22	19.5	17	32	10	26 ⁰ _{-0.03}	13	10.5	8	45	6	8	33.5	M10×1.25	15	30	M26×1.5	Rc1/8	62	107
32	22	19.5	17	32	12	26 ⁰ _{-0.03}	13	10.5	8	45	6	8	37.5	M10×1.25	15	34.5	M26×1.5	Rc1/8	64	109
40	24	21	22	41	14	32 ⁰ _{-0.04}	16	13.5	11	50	8	10	46.5	M14×1.5	21.5	42.5	M32×2.0	Rc1/4	88	138

E

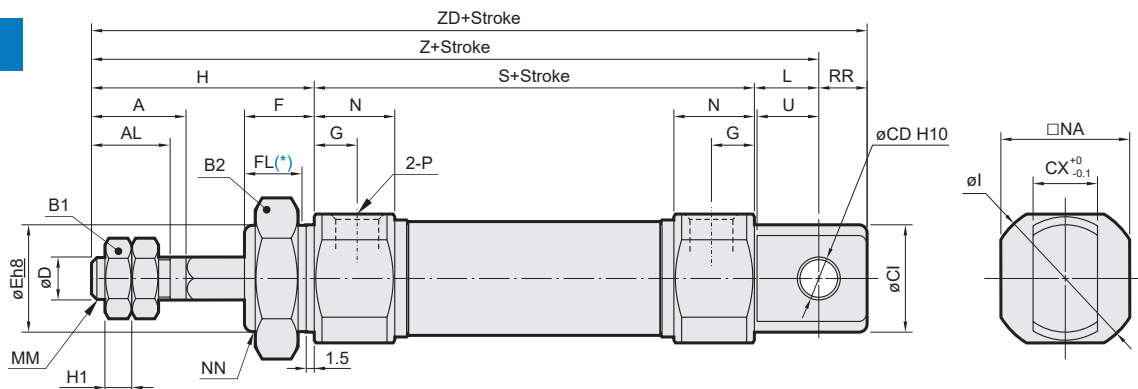

* FL: Effective thread length

Unit: mm

Code Tube I.D.	A	AL	B1	B2	CD	CX	CI	D	E	F	FL	G	H	H1	I	L	MM	N	NA	NN	P	RR	S	U	Z	ZD
20	18	15.5	13	26	8	12	20	8	20 ⁰ _{-0.03}	13	10.5	8	41	5	28	12	M8×1.25	15	24	M20×1.5	Rc1/8	9	62	11.5	115	124
25	22	19.5	17	32	8	12	22	10	26 ⁰ _{-0.03}	13	10.5	8	45	6	33.5	12	M10×1.25	15	30	M26×1.5	Rc1/8	9	62	11.5	119	128
32	22	19.5	17	32	10	20	27	12	26 ⁰ _{-0.03}	13	10.5	8	45	6	37.5	15	M10×1.25	15	34.5	M26×1.5	Rc1/8	12	64	14.5	124	136
40	24	21	22	41	10	20	33	14	32 ⁰ _{-0.04}	16	13.5	11	50	8	46.5	15	M14×1.5	21.5	42.5	M32×2.0	Rc1/4	12	88	14.5	153	165