

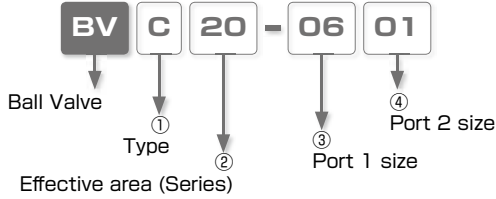

Push-In Fitting Type Shut-off Valve Ball Valve Series

- *Control Open/Close Air Supply.*
- *Ensure Effective Area for Variety of Tube Dia.*
- *Easily Adjustable lever with Scale for 10 series*
- *PPS Material for 20/60 Series. Water can be used.*

Model Designation (Example)



① Type

Code	Type	Code	Type	Code	Type	Code	Type
C	Straight	U	Union Straight	G	Unequal Dia. Union Straight	M	Bulkhead Union Straight
LC	Elbow	LU	Union Elbow	LG	Unequal Dia. Union Elbow	LM	Bulkhead Union Elbow

② Effective area (Series)

No code: 10mm²

20: 20mm²

60: 60mm²

③ Port 1 size

Code	mm Tube dia. (mm)					Taper pipe thread size			
	4	06 (6)	08	10	12	01	02	03	04
Size	ø4	ø6	ø8	ø10	ø12	R1/8	R1/4	R3/8	R1/2

※ Code in () is for code for 10 Series

④ Port 2 size

Code	mm Tube dia. (mm)					Taper pipe thread size			
	4	06 (6)	8	10	12	01	02	03	04
Size	ø4	ø6	ø8	ø10	ø12	R1/8	R1/4	R3/8	R1/2

※ Code in () is for code for 10 Series

How to open / close the valve

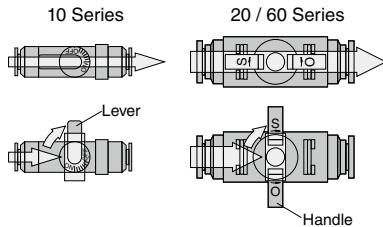

■ Air (Water) can be supplied from both sides.

10 Series : To open the valve, turn the lever 90 degrees in the counterclockwise direction. To close, turn the lever in the clockwise direction until it stops.

20 / 60 Series : To open the valve, turn the handle 90 degrees in the O (Open) direction. To close, turn the handle in S (Stop) direction until it stops.

Specifications

Series	10	20	60
Fluid medium	Air	Air / Water (※)	
Operating pressure range	0 ~ 0.7MPa	0 ~ 0.9MPa	
Max. vacuum	-100kPa		
Operating temp. range	0 ~ 60°C (No freezing)		
Effective area	10mm ²	20mm ²	60mm ²

△ Warning

※ Make sure to follow the instructions below when the fluid medium is water.

1. Surge pressure must be controlled lower than max. operating pressure when using water as a fluid medium.
2. Tap water can be used. Consult with PISCO for using other kind of water.
3. Be sure to place Insert Ring into the tube edge when using water as a fluid medium.

Construction (20/60 Series Union (Handle : Close))

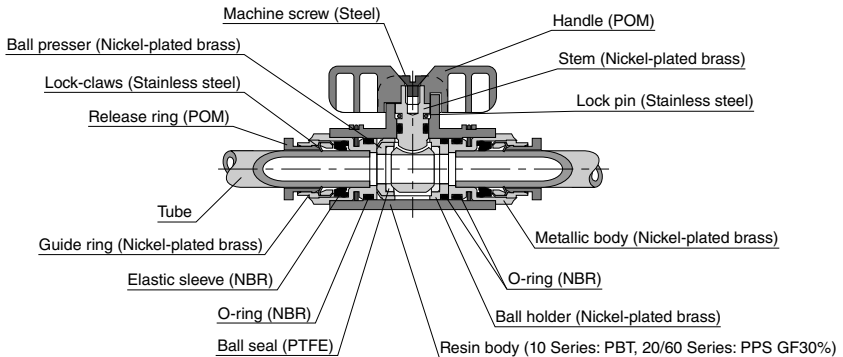

△ Detailed Safety Instructions

Before using PISCO products, be sure to read "Safety Instructions" and "Safety Instruction Manual" on page 23 to 27 and "Common Safety Instructions for Valves" on page 549 to 550.

Warning

1. When the fluid medium is water, do not use the valves unless the operating environment meets all the described specifications in the catalog. Otherwise, it may cause damage to the products, the escape of tubes and a fluid leakage.

Caution

1. Make sure to turn the handle 90 degrees. Inadequate turning can cause a poor path connection or a lack of flow amount. Excessive turning can cause damage to Ball Valve.
2. When Ball Valve is used under negative pressure, place a vacuum filter on the intake side. Vacuumed dusts can cause malfunction of pneumatic systems.
3. Do not pull out the lock pin. The valve will be dismantled without the pin. Make sure that the pin is inserted properly before using Ball Valve.



Ball Valve Series

FITTING

CONTROLLER

VALVE

Standard Size List

10 Series: Thread ⇔ Tube

Type	Page	Thread size	Tube O.D.(mm)	
			4	6
BVCI Straight	P.569	R1/8	●	
BVLC Elbow	P.571	R1/8	●	●

Type	Page	Tube O.D. (mm)	Thread size
			R1/8
BVLC Elbow	P.571	4	●
		6	●

10 Series: Tube ⇔ Tube

Type	Page	Tube O.D.1 (mm)	Tube O.D.2(mm)	
			4	6
BVUI Union Straight	P.569	4	●	
		6		●
BVGI Unequal Dia. Union Straight	P.569	6	●	
BVMI Bulkhead Union Straight	P.570	6	●	●

Type	Page	Tube O.D.1 (mm)	Tube O.D.2(mm)	
			4	6
BVUI Union Elbow	P.570	4	●	
		6		●
BVGI Unequal Dia. Union Elbow	P.570	4		●
		6	●	
BVMI Bulkhead Union Elbow	P.571	6	●	●

20/60 Series: Thread ⇔ Tube

Type	Page	Thread size	Tube O.D.(mm)			
			6	8	10	12
BVCI Straight	P.572	R1/8	●	●		
		R1/4	●	●	●	
		R3/8	●	●	●	●
		R1/2			●	●

Type	Page	Thread size	Tube O.D.(mm)			
			6	8	10	12
BVLC Elbow	P.574	R1/8	●	●		
		R1/4	●	●	●	
		R3/8	●	●	●	●
		R1/2			●	●

20/60 Series: Tube ⇔ Tube

Type	Page	Tube O.D.1 (mm)	Tube O.D.2(mm)			
			6	8	10	12
BVUI Union Straight	P.572	6	●			
		8		●		
		10			●	
		12				●
BVGI Unequal Dia. Union Straight	P.572	8	●			
		12			●	
BVMI Bulkhead Union Straight	P.573	8	●	●		
		12			●	●

Type	Page	Tube O.D.1 (mm)	Tube O.D.2(mm)			
			6	8	10	12
BVUI Union Elbow	P.573	6	●			
		8		●		
		10			●	
		12				●
BVGI Unequal Dia. Union Elbow	P.573	6	●			
		8	●			
		10			●	
		12			●	
BVMI Bulkhead Union Elbow	P.574	8	●	●		
		12			●	●

567

Change Valve

Shut-off Valve

How to insert and disconnect

1. How to insert and disconnect tubes

① Tube insertion

Insert a tube into Push-In Fitting up to the tube end. Lock-claws bite the tube and fix it automatically, then the elastic sleeve seals around the tube.

Refer to "2. Instructions for Tube Insertion" under "Common Safety Instructions for Fittings".

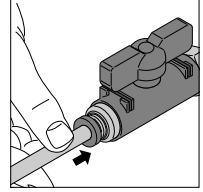

② Tube disconnection

The tube is disconnected by pushing release-ring to release Lock-claws. Make sure to stop air supply before the tube disconnection.

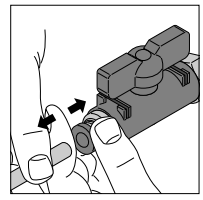

2. How to tighten thread

① Tightening thread

Use a spanner to tighten a hexagonal-column of BVC and BVLC type.

Refer to "Table: Recommended tightening torque" under "2. Instructions for Installing Valves" in "Common Safety Instructions for Valves".

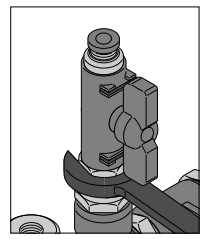

Applicable Tube and Related Products

Polyurethane Tube.....P.596

Nylon Tube.....P.608

10 Series

BVU Union Straight

RoHS compliant

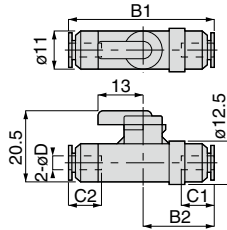

Unit : mm

Model code	Tube O.D. øD	B1	B2	Tube end C1	Tube end C2	Effective area (mm ²)	Weight (g)	CAD file name
BVU4-4	4	36.9	20.3	10.9	11	3.4	13	BVU4-4
BVU6-6	6	40.1	23.1	11.7	11.6	10.3	13	BVU6-6

BVG Unequal Dia. Union Straight

RoHS compliant

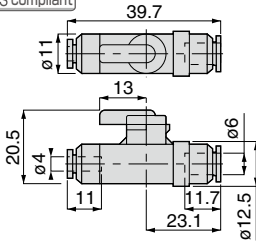

Model code	Effective area (mm ²)	Weight (g)	CAD file name
BVG6-4	3.8	13	BVG6-4



BVC Straight

RoHS compliant

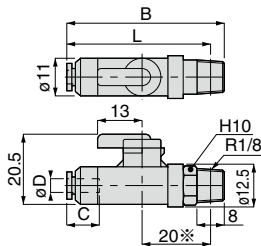

Unit : mm

Model code	Tube O.D. øD	B	L	Tube end C	Effective area (mm ²)	Weight (g)	CAD file name
BVC01-4	4	40.6	36.6	11	3.8	15	BVC01-4
BVC01-6	6	41	37	11.6	10.5	15	BVC01-6

* "L" is a reference value for height dimension after tightening thread.

BVM 10 Bulkhead Union Straight

RoHS compliant

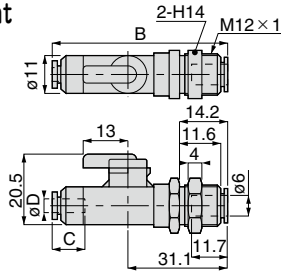

3D CAD CAD

Unit : mm

Model code	Tube O.D. øD	B	Tube end C	Effective area (mm ²)	Weight (g)	CAD file name
BVM6-4	4	47.7	11	3.8	17	BVM6-4
BVM6-6	6	48.1	11.6	10.3	17	BVM6-6

※ Release-ring on the bulkhead side is round shape.

BVLU 10 Union Elbow

RoHS compliant

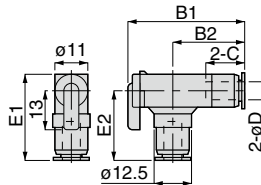

3D CAD CAD

Unit : mm

Model code	Tube O.D. øD	B1	B2	Tube end C	E1	E2	Effective area (mm ²)	Weight (g)	CAD file name
BVLU4-4	4	36.8	21.8	10.9	26.8	21.3	4	18	BVLU4-4
BVLU6-6	6	39.6	24.6	11.7	29.6	24.1	8	18	BVLU6-6

BVLG 10 Unequal Dia. Union Elbow

RoHS compliant

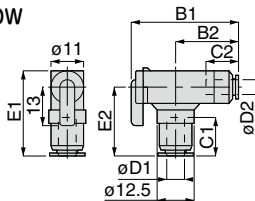

3D CAD CAD

Unit : mm

Model code	Tube O.D. øD1	Tube O.D. øD2	B1	B2	Tube end C1	Tube end C2	E1	E2	Effective area (mm ²)	Weight (g)	CAD file name
BVLG4-6	4	6	39.6	24.6	10.9	11.7	26.8	21.3	4	18	BVLG4-6
BVLG6-4	6	4	36.8	21.8	11.7	10.9	29.6	24.1	4	18	BVLG6-4

VALVE

TUBE

MAKE-TO-ORDER PRODUCTS

570

Shut-off Valve

Mechanical Valve

10 Series

BVLC Elbow

RoHS compliant

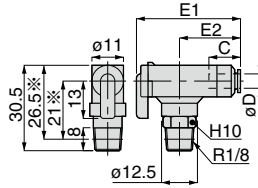

Unit : mm

Model code	Tube O.D. øD	Tube end C	E1	E2	Effective area (mm ²)	Weight (g)	CAD file name
BVLC4-01	4	10.9	36.8	21.8	4	21	BVLC4-01
BVLC6-01	6	11.7	39.6	24.6	8	21	BVLC6-01

※ Reference value for height dimension after tightening thread.

BVLC Elbow

RoHS compliant

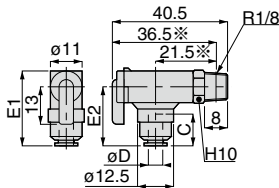

Unit : mm

Model code	Tube O.D. øD	Tube end C	E1	E2	Effective area (mm ²)	Weight (g)	CAD file name
BVLC01-4	4	10.9	26.8	21.3	4	21	BVLC01-4
BVLC01-6	6	11.7	29.6	24.1	8	21	BVLC01-6

※ Reference value for height dimension after tightening thread.

BVLM Bulkhead Union Elbow

RoHS compliant

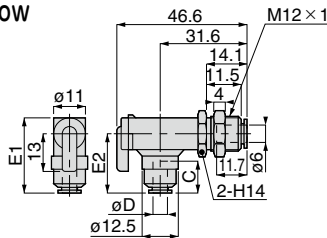

Unit : mm

Model code	Tube O.D. øD	Tube end C	E1	E2	Effective area (mm ²)	Weight (g)	CAD file name
BVLM6-4	4	10.9	26.8	21.3	4	19	BVLM6-4
BVLM6-6	6	11.7	29.6	24.1	8	19	BVLM6-6

※ Release-ring on the bulkhead side is round shape.

20/60 Series

BVU Union Straight

RoHS compliant

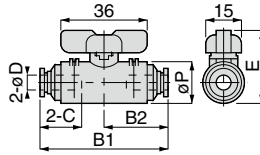

3D CAD CAD

Unit : mm

Model code	Tube O.D. ϕD	B1	B2	ϕP	Tube end C	E	Effective area (mm ²)	Weight (g)	CAD file name
BVU20-0606	6	53.9	27	17	17	31.4	10.5	45	BVU20-0606
BVU20-0808	8	55.4	27.7	17	18.2	31.4	20.5	41	BVU20-0808
BVU60-1010	10	65.4	32.7	24	20.7	37.8	41	104	BVU60-1010
BVU60-1212	12	68.6	34.3	24	23.3	37.8	55.5	100	BVU60-1212

BVG Unequal Dia. Union Straight

RoHS compliant

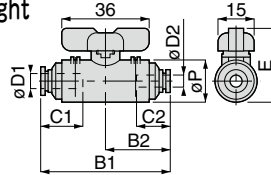

3D CAD CAD

Unit : mm

Model code	Tube O.D. $\phi D1$	Tube O.D. $\phi D2$	B1	B2	ϕP	Tube end C1	Tube end C2	E	Effective area (mm ²)	Weight (g)	CAD file name
BVG20-0806	8	6	54.7	27	17	18.2	17	31.4	13	43	BVG20-0806
BVG60-1210	12	10	67	32.7	24	23.3	20.7	37.8	40	101	BVG60-1210

BVC Straight

RoHS compliant

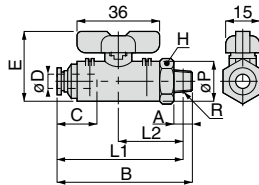

3D CAD CAD

Unit : mm

Model code	Tube O.D. ϕD	R	A	B	L1	L2	ϕP	Tube end C	E	Hex. H	Effective area (mm ²)	Weight (g)	CAD file name
BVC20-0601	6	R1/8	8	59	55	28	17	17	31.4	17	12.5	56	BVC20-0601
BVC20-0602		R1/4	11	62	55.9	29						59	BVC20-0602
BVC20-0603		R3/8	12	63	56.6	29.7						68	BVC20-0603
BVC20-0801	8	R1/8	8	59.7	55.7	28	17	18.2	31.4	17	23	22	BVC20-0801
BVC20-0802		R1/4	11	62.7	56.7	29						57	BVC20-0802
BVC20-0803		R3/8	12	63.7	57.4	29.7						66	BVC20-0803
BVC60-1002	10	R1/4	11	73.7	67.7	35	24	20.7	37.8	24	41	39.5	BVC60-1002
BVC60-1003		R3/8	12	74.7	68.4	35.7						134	BVC60-1003
BVC60-1004		R1/2	15	77.7	69.5	36.8						150	BVC60-1004
BVC60-1202	12	R1/4	11	75.3	69.3	35	24	23.3	37.8	24	55	51.5	BVC60-1202
BVC60-1203		R3/8	12	76.3	70	35.7						132	BVC60-1203
BVC60-1204		R1/2	15	79.3	71.1	36.8						148	BVC60-1204

※ "L1" and "L2" are reference values for height dimensions after tightening thread.

20/60 Series



Bulkhead Union Straight

RoHS compliant

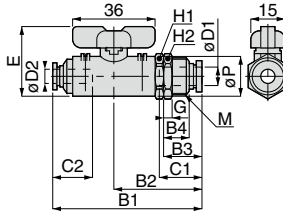

Unit : mm

Model code	Tube O.D. øD1	Tube O.D. øD2	B1	B2	B3	B4	G	øP	Tube end C1	Tube end C2	E	M	Hex. H1	Hex. H2	Effective area (mm ²)	Weight (g)	CAD file name
BVM20-0806	8	6	65.7	38.7	16.7	11.2	4	17	18.2	17	31.4	M16x1	19	19	12	49	BVM20-0806
BVM20-0808		8	66.4							18.2					47	BVM20-0808	
BVM60-1210	12	10	84	51.3	22.3	16.8	5	24	23.3	20.7	37.8	M22x1	24	27	40	118	BVM60-1210
BVM60-1212		12	85.6							23.3					115	BVM60-1212	



Union Elbow

RoHS compliant

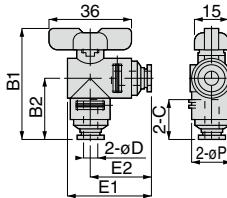

Unit : mm

Model code	Tube O.D. øD	B1	B2	øP	Tube end C	E1	E2	Effective area (mm ²)	Weight (g)	CAD file name
BVLU20-0606	6	49.2	27	17	17	37	27	9.5	46	BVLU20-0606
BVLU20-0808	8	49.9	27.7	17	18.2	37.7	27.7	18	42	BVLU20-0808
BVLU60-1010	10	60.4	35.2	24	20.7	44.7	32.7	33	107	BVLU60-1010
BVLU60-1212	12	62	36.8	24	23.3	46.3	34.3	44	102	BVLU60-1212



Unequal Dia. Union Elbow

RoHS compliant

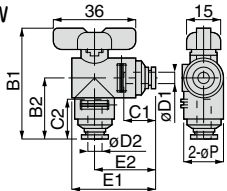

Unit : mm

Model code	Tube O.D. øD1	Tube O.D. øD2	B1	B2	øP	Tube end C1	Tube end C2	E1	E2	Effective area (mm ²)	Weight (g)	CAD file name
BVLG20-0608	6	8	49.9	27.7	17	17	18.2	37	27	12	44	BVLG20-0608
BVLG20-0806	8	6	49.2	26.9	17	18.2	17	37.7	27.7	11	44	BVLG20-0806
BVLG60-1012	10	12	62	36.8	24	20.7	23.3	44.7	32.7	39	104	BVLG60-1012
BVLG60-1210	12	10	60.4	35.2	24	23.3	20.7	46.3	34.3	36	104	BVLG60-1210

BVLC Elbow
20 60

RoHS compliant

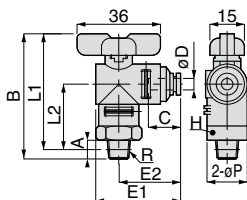

Unit : mm

Model code	Tube O.D. øD	R	A	B	L1	L2	øP	Tube end C	E1	E2	Hex. H	Effective area (mm ²)	Weight (g)	CAD file name
BVLC20-0601	6	R1/8	8	54.2	50.2	28	17	17	37	27	17	11.5	57	BVLC20-0601
BVLC20-0602		R1/4	11	57.2	51.2	29							60	BVLC20-0602
BVLC20-0603		R3/8	12	58.2	51.9	29.7							68	BVLC20-0603
BVLC20-0801	8	R1/8	8	54.2	50.2	28	17	18.2	37.7	27.7	17	17.5	54	BVLC20-0801
BVLC20-0802		R1/4	11	57.2	51.2	29							58	BVLC20-0802
BVLC20-0803		R3/8	12	58.2	51.9	29.7							66	BVLC20-0803
BVLC60-1002	10	R1/4	11	68.7	62.7	37.5	24	20.7	44.7	32.7	24	35.5	134	BVLC60-1002
BVLC60-1003		R3/8	12	69.7	63.4	38.2							136	BVLC60-1003
BVLC60-1004		R1/2	15	72.7	64.5	39.3							153	BVLC60-1004
BVLC60-1202	12	R1/4	11	68.7	62.7	37.5	24	23.3	46.3	34.3	24	44	132	BVLC60-1202
BVLC60-1203		R3/8	12	69.7	63.4	38.2							134	BVLC60-1203
BVLC60-1204		R1/2	15	72.7	64.5	39.3							151	BVLC60-1204

※ "L1" and "L2" are reference values for height dimensions after tightening thread.

BVLM Bulkhead Union Elbow
20 60

RoHS compliant

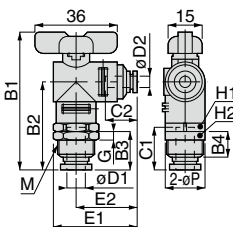

Unit : mm

Model code	Tube O.D. øD1	Tube O.D. øD2	B1	B2	B3	B4	G	øP	Tube end C1	Tube end C2	E1	E2
BVLM20-0806	8	6	60.9	38.7	16.7	11.2	4	17	18.2	17	37	27
BVLM20-0808		8								18.2	37.7	27.7
BVLM60-1210	12	10	79	53.8	22.3	17.6	5	24	23.3	20.7	44.7	32.7
BVLM60-1212		12								23.3	46.3	34.3

Model code	M	Hex. H1	Hex. H2	Effective area (mm ²)	Weight (g)	CAD file name
BVLM20-0806	M16 × 1	19	19	49	50	BVLM20-0806
BVLM20-0808				47	47	BVLM20-0808
BVLM60-1210	M22 × 1	24	27	118	120	BVLM60-1210
BVLM60-1212				114	118	BVLM60-1212

VALVE

TUBE

MAKE-TO-ORDER PRODUCTS

574

Shut-off Valve

Mechanical Valve



FITTING

CONTROLLER

VALVE

575

Change Valve

Shut-off Valve



SAFETY Instructions

This safety instructions aim to prevent personal injury and damage to properties by requiring proper use of PISCO products.

Be certain to follow ISO 4414 and JIS B 8370

ISO 4414 : Pneumatic fluid power...Recommendations for the application of equipment to transmission and control systems.

JIS B 8370 : General rules and safety requirements for systems and their components.

This safety instructions is classified into "Danger", "Warning" and "Caution" depending on the degree of danger or damages caused by improper use of PISCO products.



Danger

Hazardous conditions. It can cause death or serious personal injury.



Warning

Hazardous conditions depending on usages. Improper use of PISCO products can cause death or serious personal injury.



Caution

Hazardous conditions depending on usages. Improper use of PISCO products can cause personal injury or damages to properties.



Warning

1. Selection of pneumatic products

- ① A user who is a pneumatic system designer or has sufficient experience and technical expertise should select PISCO products.
- ② Due to wide variety of operating conditions and applications for PISCO products, carry out the analysis and evaluation on PISCO products. The pneumatic system designer is solely responsible for assuring that the user's requirements are met and that the application presents no health or safety hazards. All designers are required to fully understand the specifications of PISCO products and constitute all systems based on the latest catalog or information, considering any malfunctions.

2. Handle the pneumatic equipment with enough knowledge and experience

- ① Improper use of compressed air is dangerous. Assembly, operation and maintenance of machines using pneumatic equipment should be conducted by a person with enough knowledge and experience.

3. Do not operate machine / equipment or remove pneumatic equipment until safety is confirmed.

- ① Make sure that preventive measures against falling work-pieces or sudden movements of machine are completed before inspection or maintenance of these machine.
- ② Make sure the above preventive measures are completed. A compressed air supply and the power supply to the machine must be off, and also the compressed air in the systems must be exhausted.
- ③ Restart the machines with care after ensuring to take all preventive measures against sudden movements.

Disclaimer

1. PISCO does not take any responsibility for any incidental or indirect loss, such as production line stop, interruption of business, loss of benefits, personal injury, etc., caused by any failure on use or application of PISCO products.
2. PISCO does not take any responsibility for any loss caused by natural disasters, fires not related to PISCO products, acts by third parties, and intentional or accidental damages of PISCO products due to incorrect usage.
3. PISCO does not take any responsibility for any loss caused by improper usage of PISCO products such as exceeding the specification limit or not following the usage the published instructions and catalog allow.
4. PISCO does not take any responsibility for any loss caused by remodeling of PISCO products, or by combinational use with non-PISCO products and other software systems.
5. The damages caused by the defect of Pisco products shall be covered but limited to the full amount of the PISCO products paid by the customer.



SAFETY INSTRUCTION MANUAL

PISCO products are designed and manufactured for use in general industrial machines. Be sure to read and follow the instructions below.

Danger

1. Do not use PISCO products for the following applications.
 - ① Equipment used for maintaining / handling human life and body.
 - ② Equipment used for moving / transporting human.
 - ③ Equipment specifically used for safety purposes.

Warning

1. Do not use PISCO products under the following conditions.
 - ① Beyond the specifications or conditions stated in the catalog, or the instructions.
 - ② Under the direct sunlight or outdoors.
 - ③ Excessive vibrations and impacts.
 - ④ Exposure / adhere to corrosive gas, inflammable gas, chemicals, seawater, water and vapor. *
* Some products can be used under the condition above(④), refer to the details of specification and condition of each product.
2. Do not disassemble or modify PISCO products, which affect the performance, function, and basic structure of the product.
3. Turn off the power supply, stop the air supply to PISCO products, and make sure there is no residual air pressure in the pipes before maintenance and inspection.
4. Do not touch the release-ring of push-in fitting when there is a working pressure. The lock may be released by the physical contact, and tube may fly out or slip out.
5. Frequent switchover of compressed air may generate heat, and there is a risk of causing burn injury.
6. Avoid any load on PISCO products, such as a tensile strength, twisting and bending. Otherwise, there is a risk of causing damage to the products.
7. As for applications where threads or tubes swing / rotate, use Rotary Joints, High Rotary Joints or Multi-Circuit Rotary Block only. The other PISCO products can be damaged in these applications.
8. Use only Die Temperature Control Fitting Series, Tube Fitting Stainless SUS316 Series, Tube Fitting Stainless SUS316 Compression Fitting Series or Tube Fitting Brass Series under the condition of over 60°C (140° F) water or thermal oil. Other PISCO products can be damaged by heat and hydrolysis under the condition above.
9. As for the condition required to dissipate static electricity or provide an antistatic performance, use EG series fitting and antistatic products only, and do not use other PISCO products. There is a risk that static electricity can cause system defects or failures.
10. Use only Fittings with a characteristic of spatter-proof such as Anti-spatter or Brass series in a place where flame and weld spatter is produced. There is a risk of causing fire by sparks.
11. Turn off the power supply to PISCO products, and make sure there is no residual air pressure in the pipes and equipment before maintenance. Follow the instructions below in order to ensure safety.
 - ① Make sure the safety of all systems related to PISCO products before maintenance.
 - ② Restart of operation after maintenance shall be proceeded with care after ensuring safety of the system by preventive measures against unexpected movements of machines and devices where pneumatic equipment is used.
 - ③ Keep enough space for maintenance when designing a circuit.
12. Take safety measures such as providing a protection cover if there is a risk of causing damages or fires on machine / facilities by a fluid leakage.

⚠ Caution

1. Remove dusts or drain before piping. They may get into the peripheral machine / facilities and cause malfunction.
2. When inserting an ultra-soft tube into push-in fitting, make sure to place an Insert Ring into the tube edge. There is a risk of causing the escape of tube and a fluid leakage without using an Insert Ring.
3. The product incorporating NBR as seal rubber material has a risk of malfunction caused by ozone crack. Ozone exists in high concentrations in static elimination air, clean-room, and near the high-voltage motors, etc. As a countermeasure, material change from NBR to HNBR or FKM is necessary. Consult with PISCO for more information.
4. Special option "Oil-free" products may cause a very small amount of a fluid leakage. When a fluid medium is liquid or the products are required to be used in harsh environments, contact us for further information.
5. In case of using non-PISCO brand tubes, make sure the tolerance of the outer tube diameter is within the limits of Table 1.

● Table 1. Tube O.D. Tolerance

mm size	Nylon tube	Polyurethane tube	inch size	Nylon tube	Polyurethane tube
ø1.8mm	—	± 0.05mm	ø1/8	± 0.1mm	± 0.15mm
ø3mm	—	± 0.15mm	ø5/32	± 0.1mm	± 0.15mm
ø4mm	± 0.1mm	± 0.15mm	ø3/16	± 0.1mm	± 0.15mm
ø6mm	± 0.1mm	± 0.15mm	ø1/4	± 0.1mm	± 0.15mm
ø8mm	± 0.1mm	± 0.15mm	ø5/16	± 0.1mm	± 0.15mm
ø10mm	± 0.1mm	± 0.15mm	ø3/8	± 0.1mm	± 0.15mm
ø12mm	± 0.1mm	± 0.15mm	ø1/2	± 0.1mm	± 0.15mm
ø16mm	± 0.1mm	± 0.15mm	ø5/8	± 0.1mm	± 0.15mm

6. Instructions for Tube Insertion

- ① Make sure that the cut end surface of the tube is at right angle without a scratch on the surface and deformations.
- ② When inserting a tube, the tube needs to be inserted fully into the push-in fitting until the tubing edge touches the tube end of the fitting as shown in the figure below. Otherwise, there is a risk of leakage.

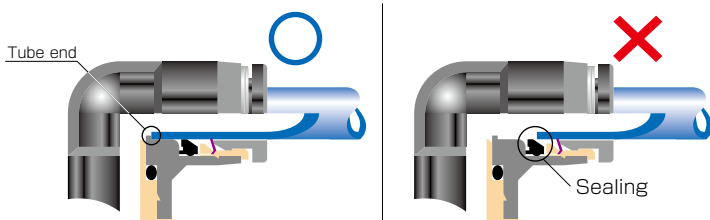

Tube is not fully inserted up to tube end.

- ③ After inserting the tube, make sure it is inserted properly and not to be disconnected by pulling it moderately.
- ※ When inserting tubes, Lock-claws may be hardly visible in the hole, observed from the front face of the release-ring. But it does not mean the tube will surely escape. Major causes of the tube escape are the followings;
- ① Shear drop of the lock-claws edge
 - ② The problem of tube diameter (usually small)
- Therefore, follow the above instructions from ① to ③, even lock-claws is hardly visible.

7. Instructions for Tube Disconnection

- ① Make sure there is no air pressure inside of the tube, before disconnecting it.
- ② Push the release-ring of the push-in fitting evenly and deeply enough to pull out the tube toward oneself. By insufficient pushing of the release-ring, the tube may not be pulled out or damaged by scratch, and tube shavings may remain inside of the fitting, which may cause the leakage later.

8. Instructions for Installing a fitting

- ① When installing a fitting, use proper tools to tighten a hexagonal-column or an inner hexagonal socket. When inserting a hex key into the inner hexagonal socket of the fitting, be careful so that the tool does not touch lock-claws. The deformation of lock-claws may result in a poor performance of systems or an escape of the tube.
- ② Refer to Table 2 which shows the recommended tightening torque. Do not exceed these limits to tighten a thread. Excessive tightening may break the thread part or deform the gasket and cause a fluid leakage. Tightening thread with tightening torque lower than these limits may cause a loosened thread or a fluid leakage.
- ③ Adjust the tube direction while tightening thread within these limits, since some PISCO products are not rotatable after the installation.

● Table 2: Recommended tightening torque / Sealock color / Gasket materials

Thread type	Thread size	Tightening torque	Sealock color	Gasket materials
Metric thread	M3 × 0.5	0.7N·m	—	SUS304 NBR
	M5 × 0.8	1.0 ~ 1.5N·m		
	M6 × 1	2 ~ 2.7N·m		
	M3 × 0.5	0.5 ~ 0.6N·m		POM
	M5 × 0.8	1 ~ 1.5N·m		
	M6 × 0.75	0.8 ~ 1N·m		
Taper pipe thread	M8 × 0.75	1 ~ 2N·m	White	—
	R1/8	7 ~ 9N·m		
	R1/4	12 ~ 14N·m		
	R3/8	22 ~ 24N·m		
Unified thread	R1/2	28 ~ 30N·m	—	SUS304, NBR
	No.10-32UNF	1.0 ~ 1.5N·m		
National pipe thread taper	1/16-27NPT	7 ~ 9N·m	White	—
	1/8-27NPT	7 ~ 9N·m		
	1/4-18NPT	12 ~ 14N·m		
	3/8-18NPT	22 ~ 24N·m		
	1/2-14NPT	28 ~ 30N·m		

※ These values may differ for some products. Refer to each specification as well.

9. Instructions for removing a fitting

- ① When removing a fitting, use proper tools to loosen a hexagonal-column or an inner hex bolt.
- ② Remove the sealant stuck on the mating equipment. The remained sealant may get into the peripheral equipment and cause malfunctions.

10. Arrange piping avoiding any load on fittings and tubes such as twist, tensile, moment load, shaking and physical impact. These may cause damages to fittings, tube deformations, bursting and the escape of tubes.



Common Safety Instructions for Valves

Before selecting or using PISCO products, read the following instructions. Read the detailed instructions for individual series as well as the instructions below.

Warning

1. Some products have an air direction to control. Make sure to distinguish the direction by the catalog or marking on the products. Installing the product with the wrong direction may cause personal injury or property damage.
2. Do not operate manual valves by machine. It may cause damage to the products.
3. Use clean air to supply and remove drainage and dusts. Place an air filter on the upstream side of valves. Impurities in the compressed air can cause malfunction of valves.
4. Avoid any load on PISCO products such as a tensile strength, twisting, bending, dropping and excessive impacts. These may cause damage to the products.

⚠ Caution

1. Refer to “Common Safety Instructions for Fittings” for the safety instructions for fitting part.
2. Instructions for Installing Valves
 - ① Use proper tools to tighten a hexagonal-column of Hand Valve and Ball Valve with taper pipe thread.
 - ② Refer to the following table which shows the recommended tightening torque to tighten thread. Excessive tightening may break the thread part or cause a fluid leakage due to the deformation of thread. Tightening thread with the tightening torque lower than these limits may cause a loosened thread or a fluid leakage.

● Table: Recommended tightening torque

Thread type	Thread size	Torque force
Taper pipe thread	R1/8	7 ~ 9Nm
	R1/4	12 ~ 14Nm
	R3/8	22 ~ 24Nm
	R1/2	28 ~ 30Nm

3. Instructions for removing Valve

- ① When removing taper pipe thread of Hand Valve and Ball Valve, use proper tools to loosen a hexagonal-column.
- ② Remove the sealant stuck on the mating equipment. The remained sealant may get into the peripheral equipment and cause malfunction.