

2-color Dual Display Flow Sensor 21



High accuracy
Max. ± 3% F.S.

Quick response time
Max. 50 msec.

- Detects leaks in vessels, etc. ■ Controls ejector air consumption
- Manages flows of ionizers, air for automated painting, etc.
- Verifies suction of small workpieces

"Flow Sensor 20 with 2-color dual display" innovated with more functions !

+ A variety of connections
Inch sizes are newly added.

+ Flexible mounting options
In addition to mounting bracket and panel mount bracket options, DIN rail mount bracket option is now available.



+ Reduction in pressure loss
Pressure loss can be reduced up to 50% by redesigning the flow path.

+ More convenient display function
Rotatable display allows readability even with inverted installation.

Indication is rotatable

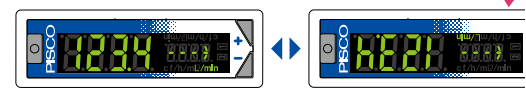

+ New setting copy function
Settings on master sensor can be copied to slave sensors.

Saving setting time

Preventing input errors of setting values

+ Measurable of five gas types
Gas type switching function is equipped.



FUS21



Space saving

Built-in needle valve type

Flow adjustable needle valve and sensor are integrated into one unit. Easy piping and space saving.

High accuracy, quick response time

Accuracy: $\pm 3\%$ F.S. or less

Precise flow measurement is possible.

Response time: 50msec or less

High-speed response is realized by incorporating a platinum sensor chip processed with silicon micromachining and contributes to shorten cycle time.

Bi-directional flow measurement

Bi-directional flow model can measure the flow of preset direction as desired and gives flexibility of plumbing installation. It can be used as a reverse flow detector.



Easy installation

Can be panel mounted. DIN rail mount option is now available.

Side-by-side installation allows shortened setting time and space saving when applying multiple sensors.

● Panel mount

● DIN rail mount

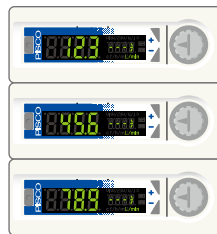
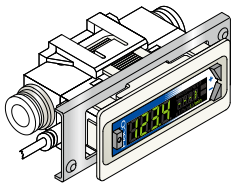

Space saving
Side-by-side
installation is possible.

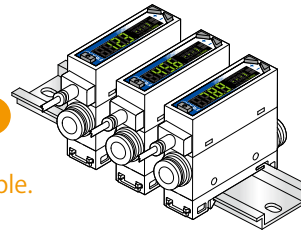

Unrestricted in mounting orientations.

The sensor can be mounted in any orientation: Top, bottom, left, or right.

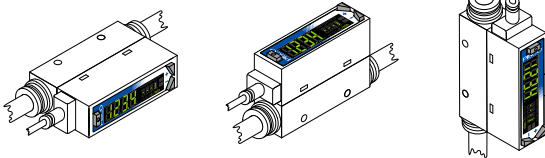

No straight piping section required.

No straight piping section is required at either upstream or downstream side.

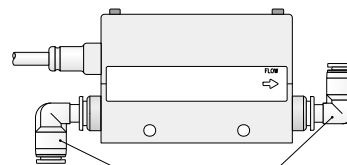

Elbow type fittings can be connected.

Readable display

Dual display/ 2-color indication

Indication of instantaneous flow rate or setting on main or sub display (dual display).

Display color can change to Green or Red for output status for normal display and switch output.

■ Dual display

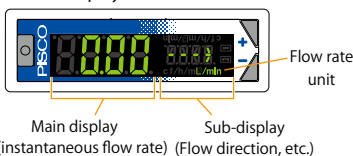

■ 2-color indication

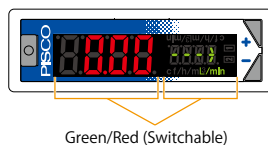

Model Designation (Example)

FUS21 ^① - NVC ^② - F ^③ 005 ^④ - 4 ^⑤ 1 ^⑥ B ^⑦ N ^⑧

①. 2-color Dual Display Flow Sensor 21

⑧. Needle valve

Code	No code	N
Needle valve	none	Built-in

⑦. Mounting bracket option

Code	Option
No code	none
B	Bracket
P	Panel-mount bracket kit
D	DIN rail-mount bracket

⑥. Connector cable

Code	No code	1	3
Cable length (m)	Without cable	1	3

⑤. Applicable tube size (dia. D)

Code	mm size				inch size	
	4	6	8	10	1/4	3/8
Tube O.D. (mm)	ø4	ø6	ø8	ø10	ø6.35	ø9.53

*) Please check the table below for the combination of flow rate range and applicable tube size.

④. Flow rate range (Full scale flow rate)

Code	Flow rate (ℓ/min)
005	0.5
010	1
020	2
050	5
100	10
200	20
500	50
101	100
201	200

*) Please check the right table for the combination of flow rate range and applicable tube size.

Table: Flow rate range and applicable tube size

		⑤. Applicable tube size code					
		4	6	8	10	1/4	3/8
④. Flow rate code	005	●	●			●	
	010	●	●			●	
	020	●	●			●	
	050	●	●			●	
	100	●	●			●	
	200	●	●			●	
	500		●	●		●	
	101			●	●		●
201			●	●		●	

③. Flow direction

Code	F	R (※)
Flow direction	Uni-direction	Bi-direction

*) Selectable only for no needle valve equipped type.

②. Output type

Code	Switch output	Analog output	Setting copy function
NVC	NPN	1 pt	1 pt (Voltage output)
NV		2 pts	1 - 5V
NAC	NPN	1 pt	1 pt (Current output)
NA		2 pts	4 - 20mA
PVC	PNP	1 pt	1 pt (Voltage output)
PV		2 pts	1 - 5V
PAC	PNP	1 pt	1 pt (Current output)
PA		2 pts	4 - 20mA

Model Designation of Accessories (Example)

FUS21 ^① - B1 ^②

①. 2-color Dual Display Flow Sensor 21

②. Option

Code	Option
B1	Bracket
P	Panel-mount bracket kit
PN	Panel-mount bracket kit for Needle Valve type
C51	5-core cable 1m
C53	5-core cable 3m
D	DIN rail-mount bracket

Specifications

Flow rate range code		005	010	020	050	100	200	500	101	201	
Flow direction	F	Uni-direction									
	R	Bi-direction									
Flow rate measurement range (*1)	F	15~500 m l /min	30~1000 m l /min	0.06~2.00 l /min	0.15~5.00 l /min	0.30~10.00 l /min	0.6~20.0 l /min	1.5~50.0 l /min	3.0~100.0 l /min	6~200 l /min	
	R	-500~-15, 15~500 m l /min	-1000~-30, 30~1000 m l /min	-2.00~-0.06, 0.06~2.00 l /min	-5.00~-0.15, 0.15~5.00 l /min	-10.00~-0.30, 0.30~10.00 l /min	-20.0~-0.6, 0.6~20.0 l /min	-50.0~-1.5, 1.5~50.0 l /min	-100.0~-3.0, 3.0~100.0 l /min	-200~-6, 6~200 l /min	
Display		4 digits + 4 digits 2-color LCD									
Flow rate display range (*2)	F	-49~549 m l /min	-99~1099 m l /min	-0.19~2.19 l /min	-0.49~5.49 l /min	-0.99~10.99 l /min	-1.9~21.9 l /min	-4.9~54.9 l /min	-9.9~109.9 l /min	-19~219 l /min	
	R	-549~549 m l /min	-1099~1099 m l /min	-2.19~2.19 l /min	-5.49~5.49 l /min	-10.99~10.99 l /min	-21.9~21.9 l /min	-54.9~54.9 l /min	-109.9~109.9 l /min	-219~219 l /min	
Integration display (*3)	Display range	0~±9999999m l			0.00~±99999.99 l			0.0~±999999.9 l			0~±9999999 l
	Pulse output rate	5m l	10m l	0.02 l	0.05 l	0.1 l	0.2 l	0.5 l	1 l	2 l	
Operating conditions	Fluid medium (*4)	Clean air (JIS B 8392-1:2012 1.1.1~5.6.2), Compressed air (JIS B 8392-1:2012 1.1.1~1.6.2), Nitrogen gas Argon gas, carbon dioxide gas and mixed gas (Argon + carbon dioxide gas)									
	Temp. range	0 to 50°C (no dew condensation)									
	Pressure range	-0.09~0.75MPa									
	Pressure proof	1MPa									
Operating ambient temp. and hum.		0 to 50°C, max. 90% RH									
Storage temperature		-10 ~ 60°C									
Accuracy (*5) (Fluid: Dry air)	Accuracy (*6)	± 3% F.S. or less (open to air at secondary side) (Guaranteed accuracy range depends on "Flow rate measurement range")									
	Repeat accuracy (*7)	± 1% F.S. or less (open to air at secondary side)									
	Temperature characteristics	MAX ± 0.2% F.S. /°C (15 to 35°C, 25°C criteria)									
	Pressure characteristics	± 5% F.S. or less (Criteria: Open to air at secondary side)								± 5% F.S. or less (Criteria: 0.35 MPa)	
Response time (*8)		50 msec or less (response time setting: OFF)									
Switch output	NV/NVC/NA/NAC	NPN open collector output (50 mA or less, voltage drop 2.4V or less)									
Analogue output (*9)	PV/PVC/PA/PAC	PNP open collector output (50 mA or less, voltage drop 2.4V or less)									
Power supply voltage (*10)	NV/NVC/PV/PVC	1 to 5 V voltage output (connected load impedance 50 kΩ and over)									
	NA/NAC/PA/PAC	4 to 20 mA current output (connected load impedance 0 to 300 Ω)									
Current consumption (*11)	NV/NVC/PA/PAC	12 to 24 VDC (10.8 to 26.4V) ripple rate 1% or less									
	NA/NAC/PA/PAC	24 VDC (21.6 to 26.4V) ripple rate 1% or less									
Lead wire		ø3.7 AWG26 equivalent × 5 cores (connector), Outside diameter of insulator is 1.0									
Functions (*12)		(1) Gas type switching, (2) Setting copy function, (3) Flow rate integration, (4) Peak hold, etc.									
Protective structure		IP40 equiv.									
Protective circuit (*13)		Power supply and switch output reverse connection protections, and switch output load short-circuit protection									
Vibration resistance		10 to 150 Hz, max. 100 m/s ² , 2 hours each in X, Y, Z direction									
EMC directive		EN55011, EN61000-6-2, EN61000-4-2/3/4/6/8									
Mounting	Mounting orientation (*14)	Unrestricted in vertical/horizontal direction									
	Straight piping section (*15)	Not required									

*1. The value converted from mass flow rate to volumetric flow rate at standard condition (20°C, 1 barometric pressure (101 kPa), relative humidity 65%). (For gas other than air, 20°C, 1 barometric pressure (101 kPa), relative humidity 0%RH).

*2. The displays of each flow rate are shown below.

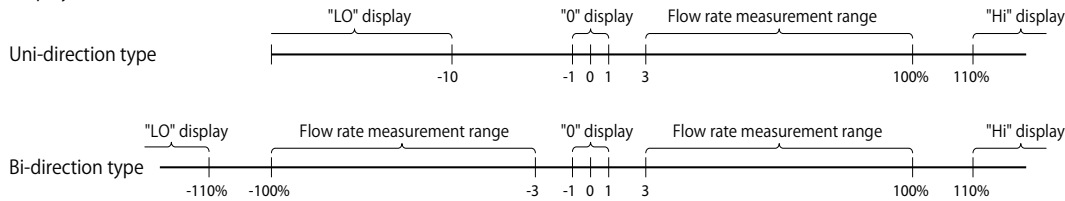

*3. The integrating flow is a calculated (reference) value. When using the integrated value save function, the number of saves should not exceed the access count limit of the storage cell (1 million times). (Changes to the settings are counted in number of accesses.)

$$\text{Number of saves} = \frac{\text{Usage time}}{5 \text{ min.}} < 1 \text{ million times}$$

When instantaneous flow rate is below 1%, it is not counted as integrated flow rate.

*4. Use dry clean gas which does not contain corrosive elements such as chlorine, sulfur or acids, and does not contain dust or oil mist. When using compressed air, use clean air that complies with JIS B 8392-1:2012 Class 1.1.1 to 1.6.2. Compressed air from the compressor contains drain (water, oil oxide, foreign substances, etc.). To maintain the function of the product, install a filter, air dryer (min. pressure dew point 10°C or less), and oil mist filter (max. oil content concentration 0.1 mg/m³) on the primary side (upstream side) of the product.

<Recommended circuit>

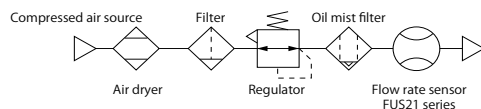

*5. Compressed air is used for adjustment and inspection of this product. Accuracy for gas types other than air is only a guide.

*6. The accuracy is based on the manufacturer's basic flow rate meter. It does not represent absolute accuracy.

Repeatability, temperature characteristics, and pressure characteristics are not included in accuracy ± 3% F.S.

Consider this condition according to the operating environment and operating conditions.

*7. Repeatability over a short period of time. Changes over time are not included.

*8. Actual response time may differ depending on piping conditions. Response time can be set within the range of 50 msec. to 1.5 sec.

- *9. Output impedance of analog voltage output type is about 1kΩ. In the case impedance of connected load is low, the margin of output value increases. Check the margin of connected load before using the product.
- *10. The power supply voltage specifications differ for the voltage output type and the current output type.
- *11. Current when 24 VDC is connected and no load is applied. The current consumption will vary depending on how the load is connected.
- *12. Gas can be switched to argon, carbon dioxide, argon 80% + carbon dioxide 20% with the gas type switching function.
The full-scale flow rate becomes half of the flow rate range when switching to carbon dioxide gas. Also, an output type can be selected for analog output.

Gas type	Flow direction	Flow rate measurement range								
		005	010	020	050	100	200	500	101	201
• Air • Nitrogen • Argon • Argon 80% + Carbon dioxide 20%	Uni-direction	15~500 m l / min	30~1000 m l / min	0.06~2.00 l / min	0.15~5.00 l / min	0.30~10.00 l / min	0.6~20.0 l / min	1.5~50.0 l / min	3.0~100.0 l / min	6~200 l / min
	Bi-direction	-500~-15 m l / min	-1000~-30 m l / min	-2.00~-0.06 l / min	-5.00~-0.15 l / min	-10.00~-0.30 l / min	-20.0~-0.6 l / min	-50.0~-1.5 l / min	-100.0~-3.0 l / min	-200~-6 l / min
• Carbon dioxide	Uni-direction	15~250 m l / min	30~500 m l / min	0.06~1.00 l / min	0.15~2.50 l / min	0.30~5.00 l / min	0.6~10.0 l / min	1.5~25.0 l / min	3.0~50.0 l / min	6~100 l / min
	Bi-direction	-250~-15 m l / min	-500~-30 m l / min	-1.00~-0.06 l / min	-2.50~-0.15 l / min	-5.00~-0.30 l / min	-10.0~-0.6 l / min	-25.0~-1.5 l / min	-50.0~-3.0 l / min	-100~-6 l / min

Gas type	Flow direction	Analog output			
		Output type A		Output type B	
		Voltage	Current	Voltage	Current
• Carbon dioxide	Uni-direction	1~3V	4~12mA	1~5V	4~20mA
	Bi-direction	2~4V	8~16mA		

The "Setting copy function" option can be selected at "Output type" in the model designation. Note that the "External input" function is not available on models with "Setting copy function".

- *13. The protection circuit of this product is effective only for specific erroneous connections and load short-circuit. It is not designed to protect from any erroneous connections.
- *14. This product measures the change in heat distribution caused by the fluid flow. When this product is mounted in vertical orientation, convection flow can influence heat distribution and cause the zero point to deviate.
- *15. Accuracy may be affected by the piping conditions. For more accurate measurement, provide a straight pipe section 10 times as long as the pipe inner diameter.

Sectional drawing

■ No needle valve type

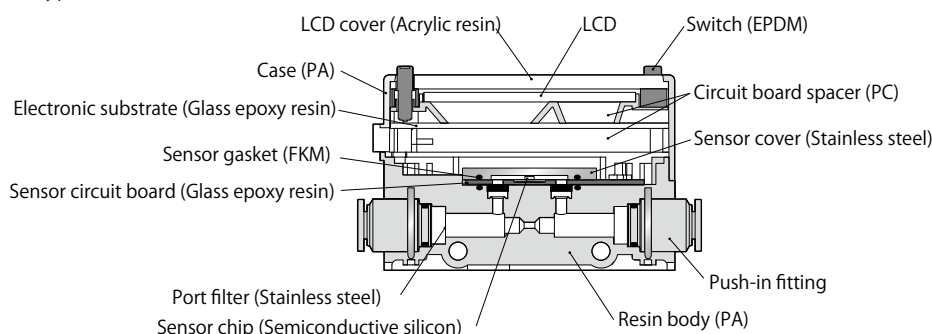

■ Built-in needle valve type

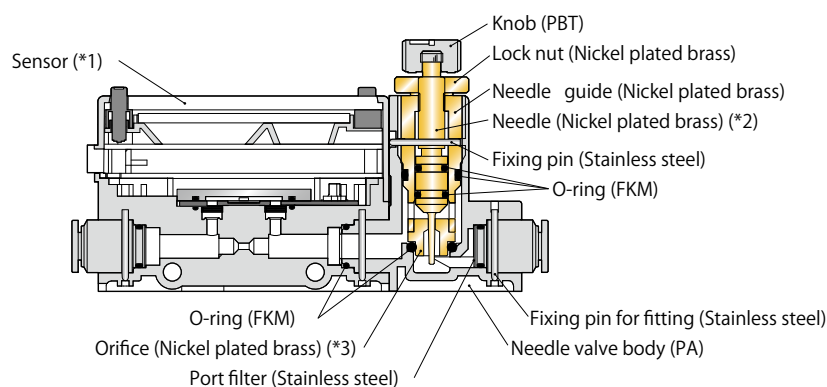

- *1. Please refer to no needle type for the main parts of the sensor.
- *2. Needle of FUS21: 005/010/020 is stainless steel.
- *3. Orifice of FUS21: 005/010/020 is PTFE.

Exterior dimensional drawings

FUS21 No needle valve

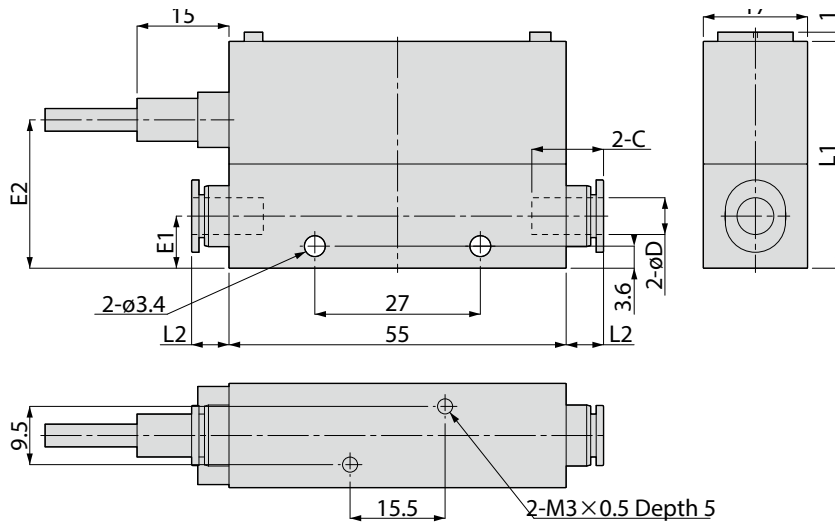

mm size

Unit: mm

Model code	Tube O. D. ϕD	L1	L2	Tube end C	E1	E2	Weight (g)
FUS21- 2 - 3 4 -4	4	37	5	10.9	8.5	—	51.6
FUS21- 2 - 3 4 -41						24.2	73.4
FUS21- 2 - 3 4 -43						—	117.1
FUS21- 2 - 3 4 -6	6	37	6.1	11.7	8.5	—	49.4
FUS21- 2 - 3 4 -61						24.2	71.2
FUS21- 2 - 3 4 -63						—	114.9
FUS21- 2 - 3 4 -8	8	43	9.2	18.2	13	—	72.7
FUS21- 2 - 3 4 -81						30.2	94.5
FUS21- 2 - 3 4 -83						—	138.2
FUS21- 2 - 3 4 -10	10	43	17.2	20.7	13	—	84.4
FUS21- 2 - 3 4 -101						30.2	106.2
FUS21- 2 - 3 4 -103						—	149.9

Inch size

Unit: mm

Model code	Tube O. D. ϕD	L1	L2	Tube end C	E1	E2	Weight (g)
FUS21- 2 - 3 4 -1/4	1/4	37	7.9	12.4	8.5	—	50.8
FUS21- 2 - 3 4 -1/41						24.2	72.6
FUS21- 2 - 3 4 -1/43						—	116.3
FUS21- 2 - 3 4 -3/8	3/8	43	17.3	20.7	13	—	83.9
FUS21- 2 - 3 4 -3/81						30.2	105.7
FUS21- 2 - 3 4 -3/83						—	149.4

*1. Please select output type for **2**, flow direction for **3** and flow rate range for **4** in model code respectively from the model designation on page 3.

*2. To get the total weight with optional accessories (panel mount bracket kit, bracket, and DIN rail mount bracket kit), the weight of each optional accessory needs to be added to the weight of the sensor (main body).

FUS21-N Built-in needle valve

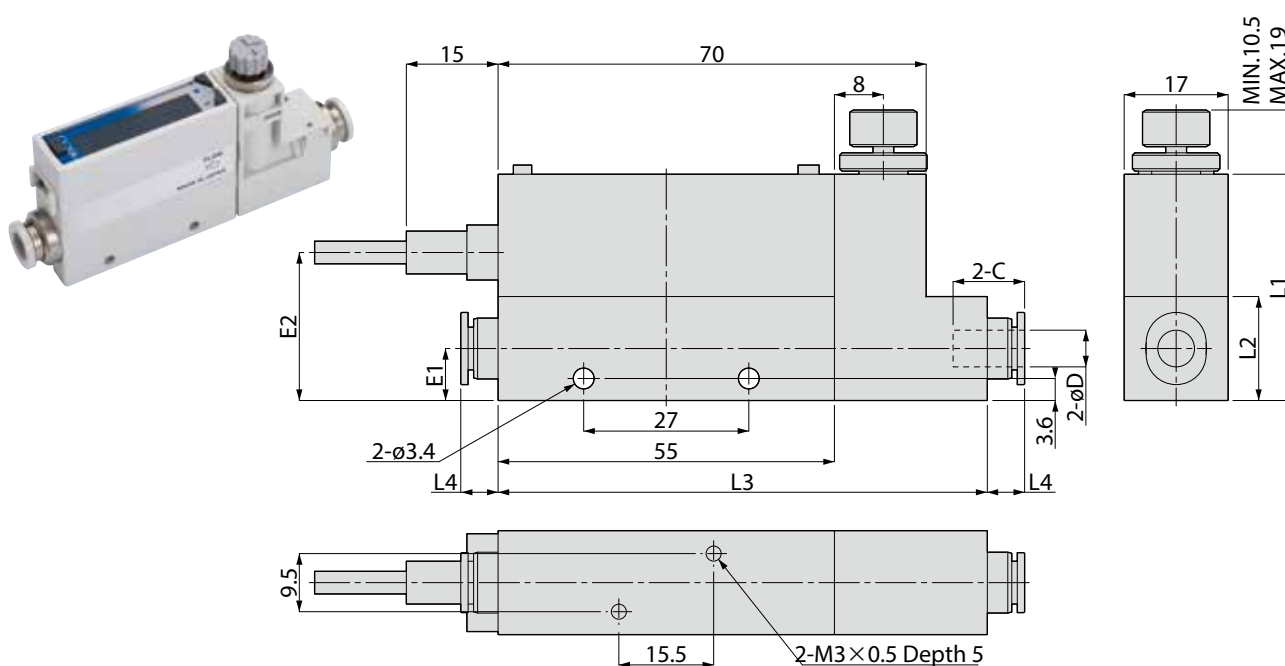

mm size

Unit: mm

Model code	Tube O. D. øD	L1	L2	L3	L4	Tube end C	E1	E2	Weight (g)
FUS21- 2 - 3 4 -4N	4	37	17	80	5	10.9	8.5	—	85.7
FUS21- 2 - 3 4 -41N								24.2	107.5
FUS21- 2 - 3 4 -43N								—	151.2
FUS21- 2 - 3 4 -6N	6	37	17	80	6.1	11.7	8.5	—	83.5
FUS21- 2 - 3 4 -61N								24.2	105.3
FUS21- 2 - 3 4 -63N								—	149
FUS21- 2 - 3 4 -8N	8	43	23	86	9.2	18.2	13	—	111.7
FUS21- 2 - 3 4 -81N								30.2	133.5
FUS21- 2 - 3 4 -83N								—	177.2
FUS21- 2 - 3 4 -10N	10	43	23	86	17.2	20.7	13	—	123.4
FUS21- 2 - 3 4 -101N								30.2	145.2
FUS21- 2 - 3 4 -103N								—	188.9

Inch size

Unit: mm

Model code	Tube O. D. øD	L1	L2	L3	L4	Tube end C	E1	E2	Weight (g)
FUS21- 2 - 3 4 -1/4N	1/4	37	17	80	7.9	12.4	8.5	—	84.9
FUS21- 2 - 3 4 -1/41N								24.2	106.7
FUS21- 2 - 3 4 -1/43N								—	150.4
FUS21- 2 - 3 4 -3/8N	3/8	43	23	86	17.3	20.7	13	—	122.8
FUS21- 2 - 3 4 -3/81N								30.2	144.6
FUS21- 2 - 3 4 -3/83N								—	188.3

*1. Please select output type for **2**, flow direction for **3** and flow rate range for **4** in model code respectively from the model designation on page 3.

*2. To get the total weight with optional accessories (panel mount bracket kit, bracket, and DIN rail mount bracket kit), the weight of each optional accessory needs to be added to the weight of the sensor in the table.

*3. Prices are listed on Page 10.

Exterior dimensional drawings

FUS21-P Panel-mount bracket kit (for no needle valve type)

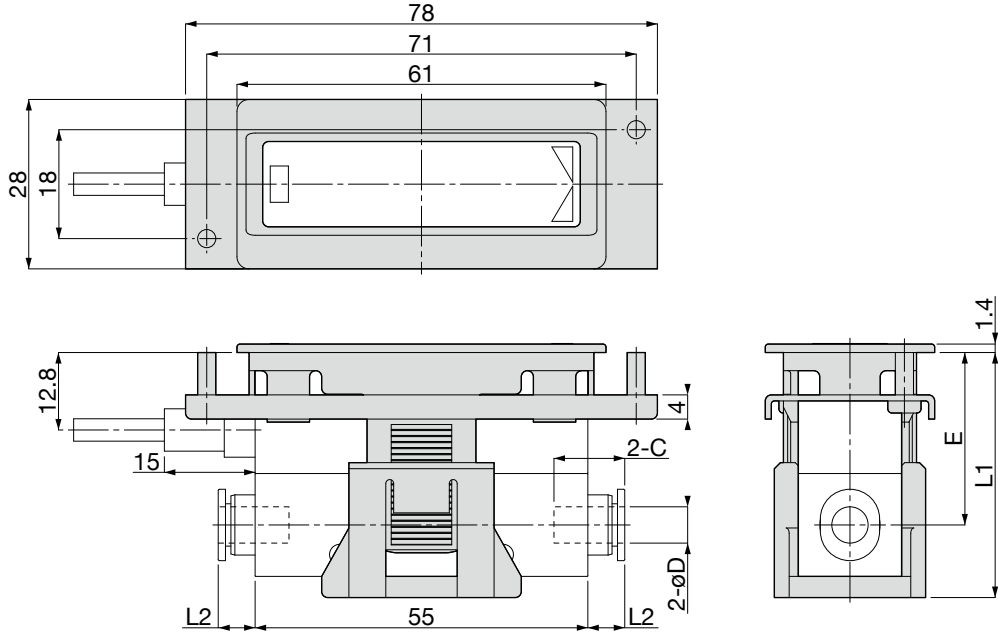

Model code	Weight (g)
FUS21-P	20.9

■ Mounting dimensions (mm size) Unit: mm

Model code	Tube O. D. ϕD	L1	L2	Tube end C	E
FUS21- 2-34-4-6 P	4	40.5	5	10.9	28.5
FUS21- 2-34-6-6 P	6	40.5	6.1	11.7	28.5
FUS21- 2-34-8-6 P	8	46.5	9.2	18.2	30
FUS21- 2-34-10-6 P	10	46.5	17.2	20.7	30

■ Mounting dimensions (Inch size) Unit: mm

Model code	Tube O. D. ϕD	L1	L2	Tube end C	E
FUS21- 2-34-1/4-6 P	1/4	40.5	7.9	12.4	28.5
FUS21- 2-34-3/8-6 P	3/8	46.5	17.3	20.7	30

* Please select output type for **2**, flow direction for **3**, flow rate range for **4**, and cable length for **6** in model code respectively from the model designation on page 3.

<Panel cut dimensions>

■ Single installation

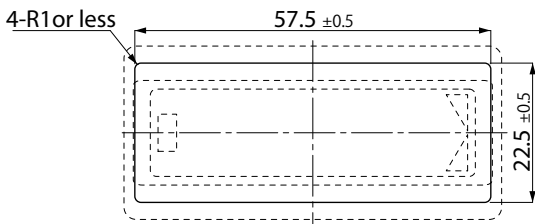

■ Side-by-side installation

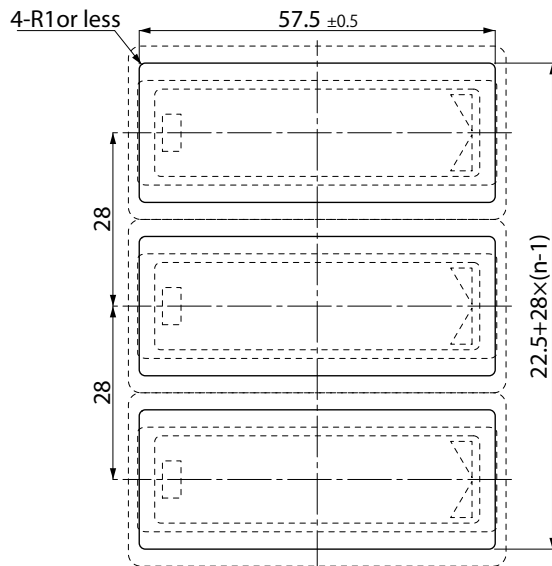

FUS21-PN Panel-mount bracket kit (for built-in needle valve type)

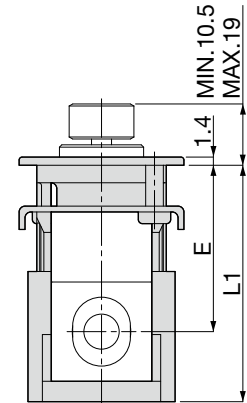
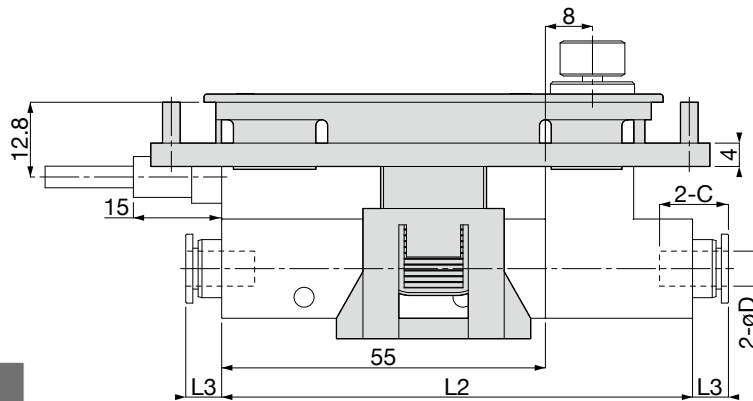
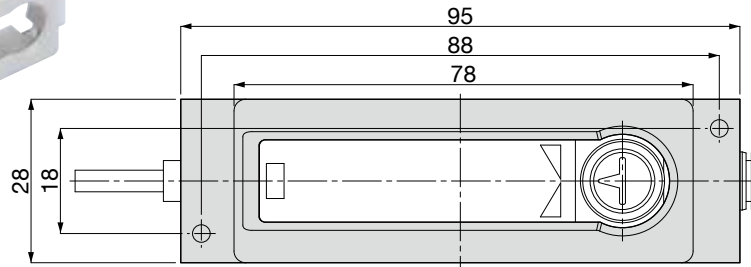
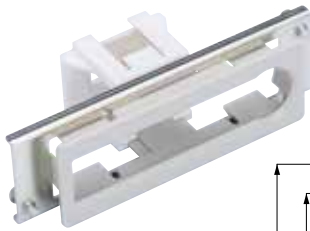

Model code	Weight (g)
FUS21-PN	23.7

■ Mounting dimensions (mm size)

Unit: mm

Model code	Tube O.D. øD	L1	L2	L3	Tube end C	E
FUS21- 2 - 3 4 - 4 6 PN	4	40.5	80	5	10.9	28.5
FUS21- 2 - 3 4 - 6 6 PN	6	40.5	80	6.1	11.7	28.5
FUS21- 2 - 3 4 - 8 6 PN	8	46.5	86	9.2	18.2	30
FUS21- 2 - 3 4 - 10 6 PN	10	46.5	86	17.2	20.7	30

■ Mounting dimensions (Inch size)

Unit: mm

Model code	Tube O.D. øD	L1	L2	L3	Tube end C	E
FUS21- 2 - 3 4 -1/4 6 PN	1/4	40.5	80	7.9	12.4	28.5
FUS21- 2 - 3 4 -3/8 6 PN	3/8	46.5	86	17.3	20.7	30

* Please select output type for **2**, flow direction for **3**, flow rate range for **4**, and cable length for **6** in model code respectively from the model designation on page 3.

<Panel cut dimensions>

■ Single installation

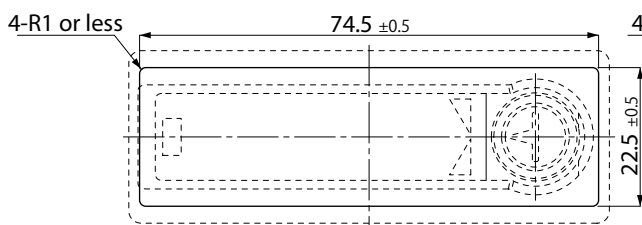

■ Side-by-side installation

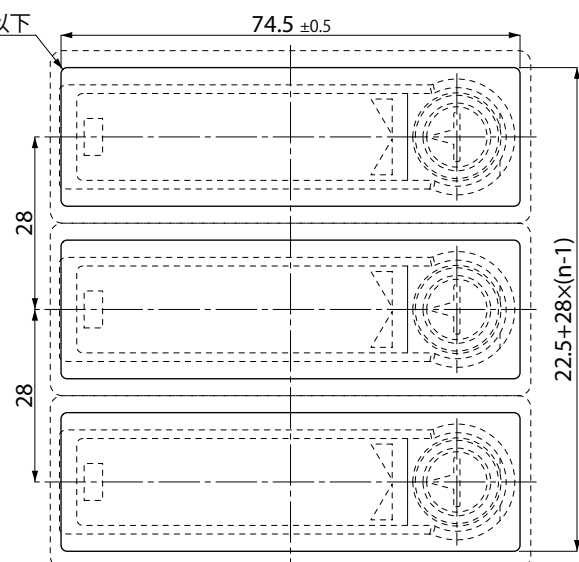

Exterior dimensional drawings

FUS21-B1 Bracket

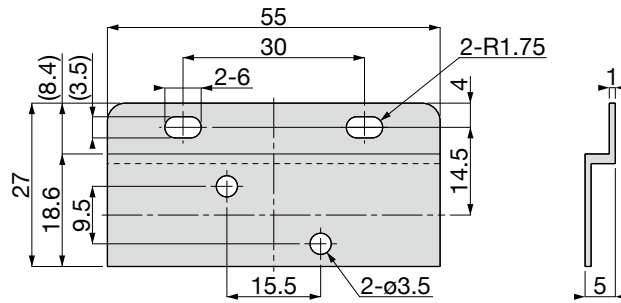

Model code	Weight (g)
FUS21-B1	12.2

FUS21-D DIN rail-mount bracket

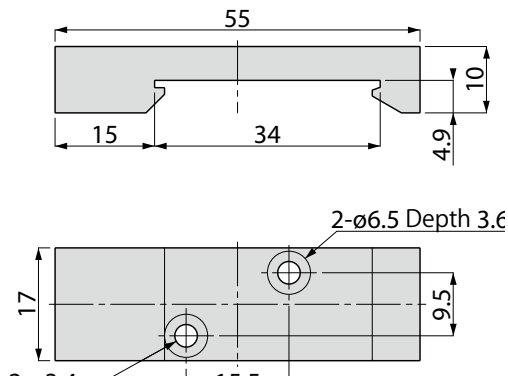

Mode code	Weight (g)
FUS21-D	6.5

FUS21-C□ 5-core cable

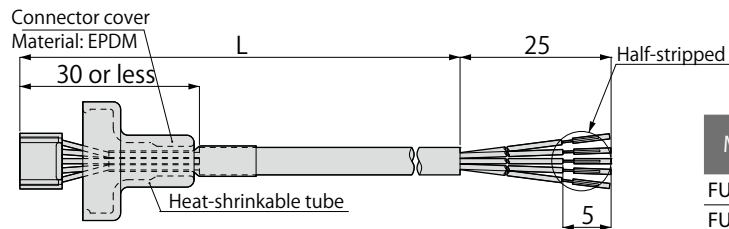

Model code	L	Weight (g)
FUS21-C51	1040±20	21.8
FUS21-C53	3040±20	65.5

Pressure loss characteristics (No needle valve type)

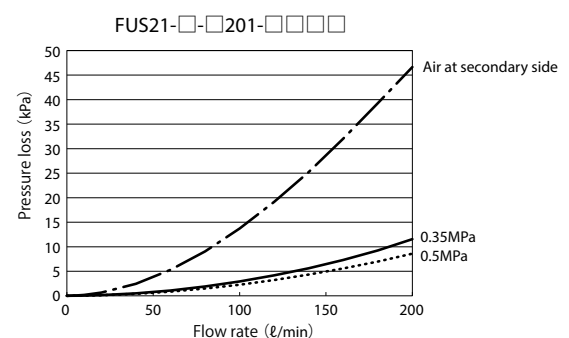
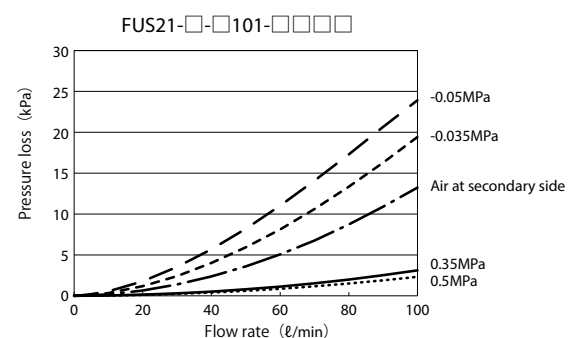
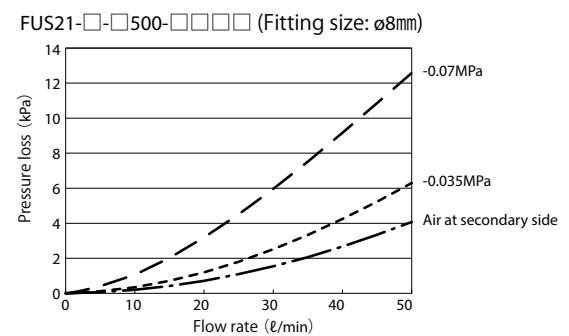
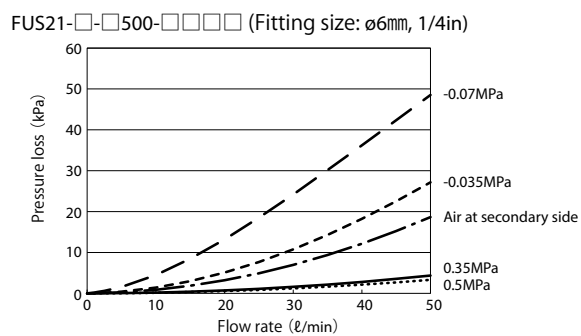
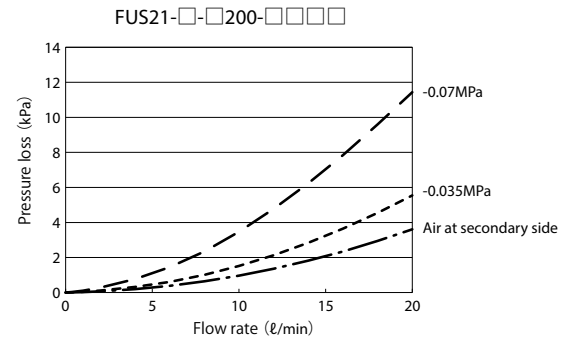
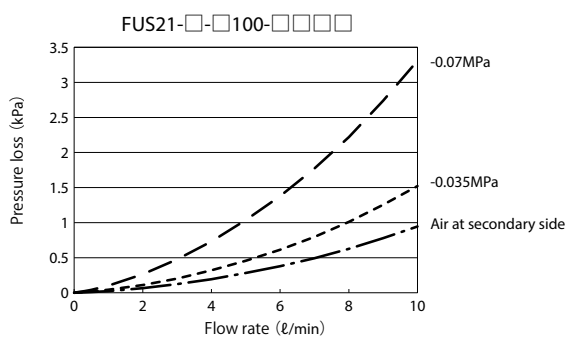
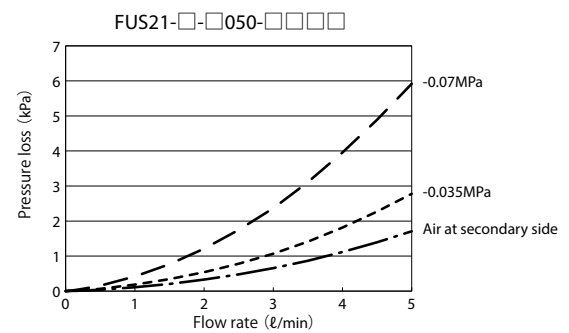
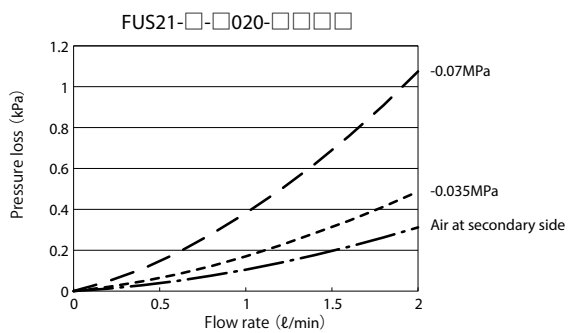
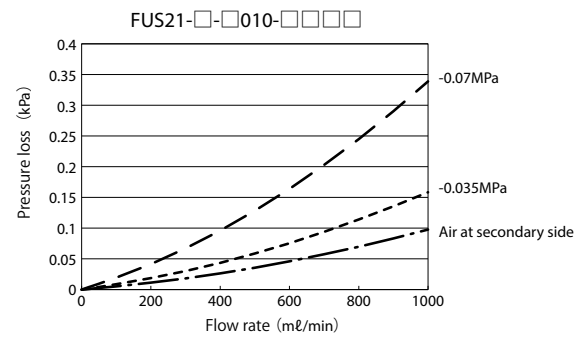
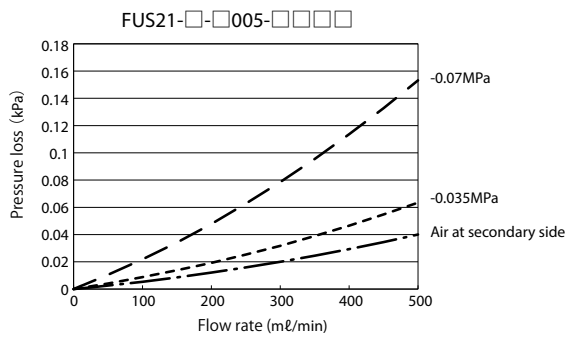

Needle valve flow characteristics

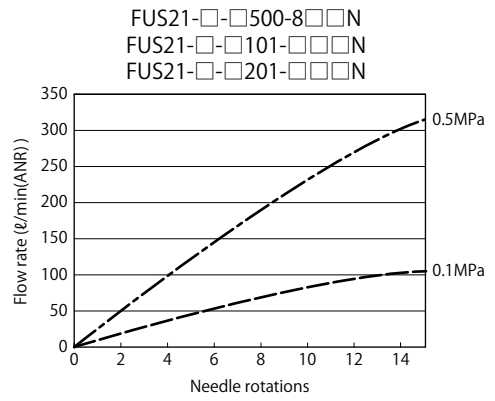
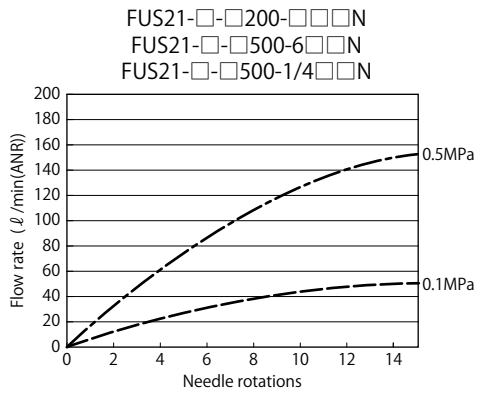
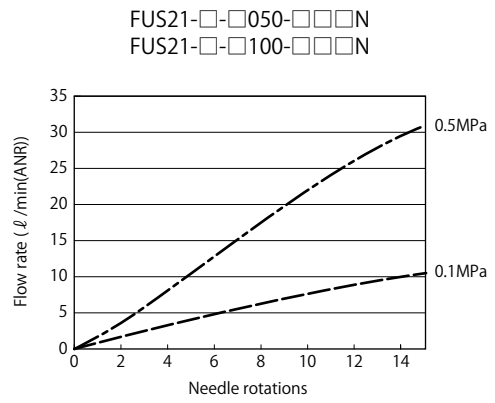
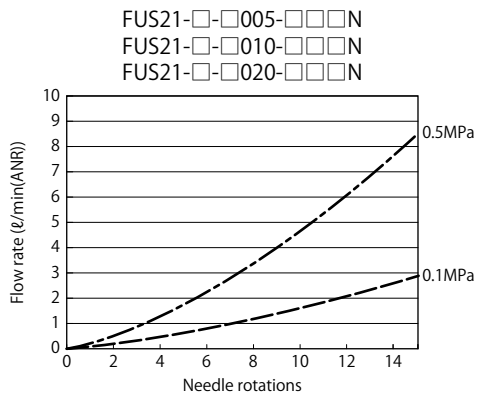

△ Safety instructions

⚠ Danger

- Never vacuum up inflammable, explosive gases. Never use the product in the potentially flammable atmosphere, such as inflammable or explosive gas. If not followed, it may cause explosion or fire.

⚠ Warning

- As it does not comply with Japanese Measurement Law and equivalent regulations in other countries, do not use for commercial transactions.
- Use dry gas which does not contain corrosive elements such as chlorine, sulfur or acids, and which is clean and does not contain dust or oil mist. Depending on the fluid, retaining the fluid for a long time could adversely affect the performance. Do not seal the fluid in the pipe for long periods of time. If this product is contaminated by foreign objects (dust and water drops inside piping, oil mist, etc.), the accuracy and control performance may deteriorate and cause failure. If it may be contaminated by foreign objects, attach a filter, air dryer and oil mist filter on the primary side (upstream) of this product.
- This product may malfunction and result in failure due to grease on the valve, diffused oil, and abrasion powder generated from the valve. When using a valve on the primary side of this product, use a valve with oil-free specification and attach a filter.
- Faults could result if the liquefied gas enters this product. When using the product with liquefied gases such as carbon dioxide, always vaporize the gas.

⚠ Caution

- Do not use the product out of the measured flow range in the specification, although the product does not get damaged by temporal flow rate up to about twice as large as the specification value.
- Using the product above max. operating pressure, below min. operating pressure or out of the measured flow range may cause failures. If the product is energized under a vacuum of -0.09 MPa or less, the heat dissipation from the sensor will be poor, leading to deterioration of the sensor. In addition, even within the specified pressure range, depending on the pressure conditions on the primary and secondary sides of the product, excessive flow may occur and the sensor inside the product may malfunction. Install a bypass circuit or a throttle to prevent excessive flow from flowing into the product. Please be noted that overflow is likely to occur especially when using the product at high pressure.
- The needle valve in this product allows leakage to some extent. The needle valve cannot be used as the stop valve that leakage is required to be zero.
- The flow path is not completely free of dust generation. A hollow fiber membrane filter (MFU series) should be used in circuits where dust generation could be a problem.
- Please note the followings when using the product for suction verification.
 - (1). Install an air filter upstream of the intake side to prevent the entry of foreign matter.
 - (2). Use the product under conditions where no condensation occurs in the piping, taking into account the dew point of the atmosphere and the ambient temperature around the product.
 - (3). Do not bend the tube near the push-in fitting when using it for vacuum applications such as air intake. If stress is applied to the tube near the push-in fitting, place the insert ring into the tube edge and then insert it into the push-in fitting.
 - (4). When the sensor for suction verification is replaced from the pressure sensor (switch) to the flow sensor (switch), the theory of sensor output (switch output) is reversed as in the right figure.

Care must be taken since change and modification of sequence program of PLC are required. If source pressure/vacuum is not supplied when equipment power turned on, take necessary treatment to prevent problems in sequence program, etc., of PLC since flow sensor (switch) maintains [flow rate 0] = [sensor output (switch output) ON].
 - (5). Select the flow rate range based on the operating vacuum pressure and suction nozzle diameter. Response speed may be delayed due to the piping volume between the suction nozzle and this product. If that is the case, take measures such as reducing the volume.
- The case is made of resin. Do not use solvents, alcohol, and cleaning detergents to clean this product because the resin could absorb these chemicals. Wipe off dirt with a rag soaked in a diluted neutral detergent solution and wrung out well.
- It is recommended to verify the flow rate accuracy periodically. Depending on the customer's use environment and condition, the accuracy may fluctuate from the initial performance. Also, if used for a long time, the accuracy may fluctuate due to sensor chip deterioration.

	Pressure sensor (switch) Above setting value ON	Flow sensor (switch) Below setting value ON
Suction verification		

For the detailed operational procedures for 2-color Dual Display Flow Sensor 21, please refer to the instruction manual on our website.

Instruction Manual (full version)

▶ <https://www.pisco.co.jp/dl/pdf/HIR0096-00.pdf>



Installation Environment

Warning

- Please do not use the product in an environment containing corrosive gas such as sulfurous acid gas, or etc.
- Please do not install the product in an area where moisture, salt, dust or swarf is present, or under a pressurized or depressurized environment. The protective structure of this product is equivalent to IP40. This product cannot be used in a place where the temperature changes rapidly or in an environment with high humidity, as condensation may cause damage inside the main unit.

Caution

- Always perform piping and installation before wiring.
- Please flash the pipe by air blow to remove foreign substances and swarf before piping. Foreign materials or swarf inside piping may damage rectification plate and platinum sensor.
- Be sure to insert the tube securely and pull the tube to make sure it will not come off. Cut the tube at a right angle with a tube cutter before use.
- After piping, make sure there are no gas leaks.
- Do not install a pressure reducing valve (regulator), solenoid valve, etc. immediately before this product. This may cause deflection of the flow and lead to errors. If necessary, install a straight pipe section.
- When performing a leakage test on a piping, make sure that the leak detection liquid does not enter the case.
- Do not turn the fitting while applying fluid pressure on this product.
- The main unit can be installed vertically or horizontally, but the flow rate may vary depending on the installing position and piping conditions.
- Self-heat generation of each product can cause the temperature of product main body to rise, promoting characteristic changes and resin material changes. When placing them side by side, leave a space for 10 mm or more between them.
- Since liquid crystal is used on the flow rate display part, it may be hard to read in certain angles.
- Do not turn the knob of the needle valve with excessive force (0.05 N · m or less). Also, do not adjust the needle by picking the lock nut. Doing so may cause galling or damage to the needle.
- Do not overly tighten the knob of the needle valve. If it is tightened too tightly when fully-closed, the setting flow rate may fluctuate.
- Make sure that the lock nut of the needle valve is not loose.
- The needle valve is equipped with a retaining mechanism; however, if the needle is turned too much, it may cause damage.

Installation

Horizontal (through hole)

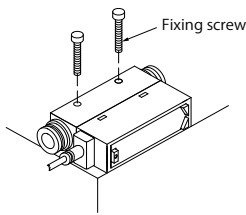

Vertical (female thread on the bottom)

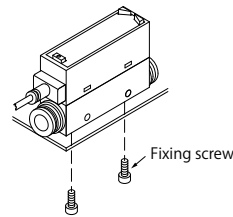

Bracket installation

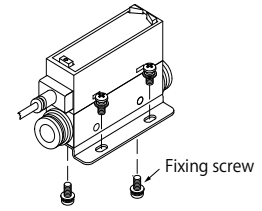

• Tightening torque of fixing screw is 0.5N.m.

Panel mount installation (no needle valve)

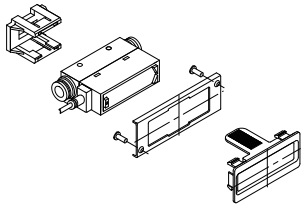

Panel mount installation (with needle valve)

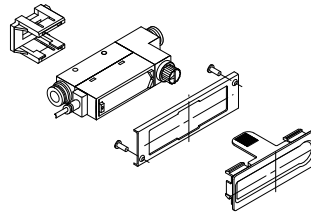

Installing on a DIN rail

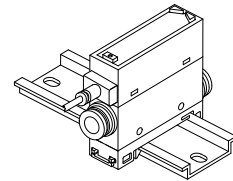

①	②	③
<p>Insert the panel bezel from the front side of the panel. For panel cut dimension, refer to the exterior dimensional drawings.</p> <p>Panel Panel bezel</p>	<p>Insert the panel bezel holder from the back side of the panel (using the tabs on the panel bezel), and fix it with the screw.</p> <p>Screw Panel bezel holder</p>	<p>Install the sensor from the back side of the panel.</p> <p>Sensor</p>
④	⑤	
<p>Install the panel holder from the back side of the panel.</p> <p>Panel holder</p>	<p>Push the panel holder until the sensor is firmly fixed and connect the connector.</p>	

- Tightening torque of a fixing screw for a panel bezel is 0.06N.m.
- Make sure to complete piping before panel mounting so as not to apply excessive force to panel mount parts and cause damage.
- When mounting the panel, try to avoid vibration to the product as much as possible.
- For panel cut dimensions, please refer to the exterior dimensional drawings in the catalog.

Piping

● Cleaning the pipes

Please flash the pipe by air blow to remove foreign substances and swarf before piping. Foreign materials or swarf inside piping may damage rectification plate and platinum sensor.

● Piping direction

Align the direction of the fluid medium with the direction indicated on the body when piping.

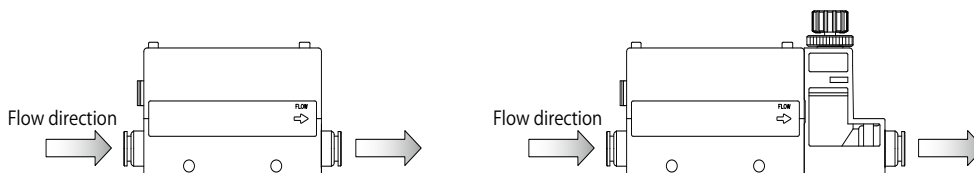

Wiring

⚠ Danger

- Applying a voltage exceeding the specified power supply voltage range may result in malfunction, product rupture, electric shock, or fire.
- Connecting a load that exceeds the rating of the output may cause damage to the output circuit or a fire.

⚠ Warning

- Since incorrect wiring can lead to damage, malfunction, or failure of the product, please check the color of the wiring in the instruction manual before wiring.
- Make sure that there is no contact with other circuits, ground faults, or poor insulation between terminals. Overcurrent may flow in this product causing damage.
- Use a DC stabilized power supply within the rating that is isolated from the AC power supply for this product. An uninsulated power supply may cause electric shock.
- Also, an unstabilized power supply may cause the peak value to exceed the rating, damaging the product or deteriorating its accuracy.
- For wiring, stop control unit/machinery and equipment, and turn off the power supply. Sudden operation may create unexpected behavior, causing a danger. While control unit, machinery and equipment are stopped, perform energization test, then set the necessary data. Discharge static electricity built in body, tool and equipment before and during work. Use a wire with elasticity such as wire for robot in the movable part.
- This product and wiring must be installed as far away as possible from noise source such as strong electric line, etc.
- Please do not short-circuit a load, otherwise, it may cause damage or burn.
- Do not wire the power supply polarity incorrectly. It may cause damage and burnout.
- Check the impedance of the connected load before use.

Output impedance of analog voltage output type is 1kΩ. In the case impedance of connected load is low, the output value and error increase. Check the margin of connected load before using the product. (The analog output current output type is excluded.)

<Example of calculation>

FU21 (Voltage output) impedance: $R_0 = 1k\Omega$

Internal load impedance : $R_x = 1M\Omega$

$$\text{Output value} = \left(1 - \frac{R_0}{R_0 + R_x}\right) \times 100\% = \left(1 - \frac{1k\Omega}{1k\Omega + 1M\Omega}\right) \times 100\% \Rightarrow \text{Output error approx. 0.1\%}$$

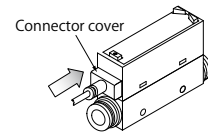

- Do not apply stress (7N or more) to the cable pull-out section and connector section.
- Always attach the connector cover after connecting the connector.
- Be sure to turn off the power before plugging in or unplugging the cable.
- Insulate the unused wires so that they do not come into contact with other wires. If unused wires are connected to ground or other sources by mistake, the product may be damaged or malfunction.

● NPN output

FUS21-NV / NA (1 analog, 2 switches)

Using CH2 as switch output

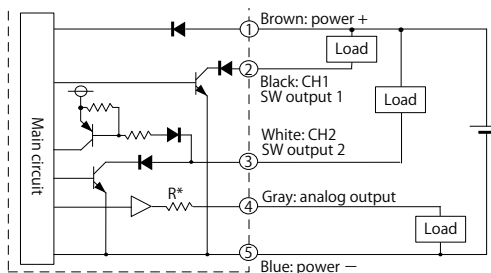

Using CH2 as external input

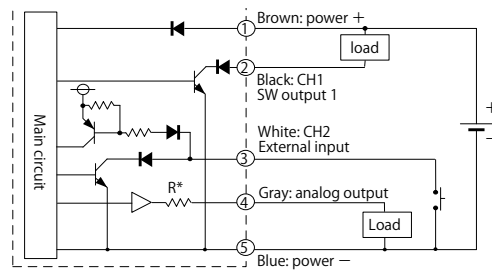

FUS21-NVC / NAC (1 analog, 1 switch, With copy function)

Model with the copy function

* When using the copy function, please refer to "Copying setting values" on the next page.

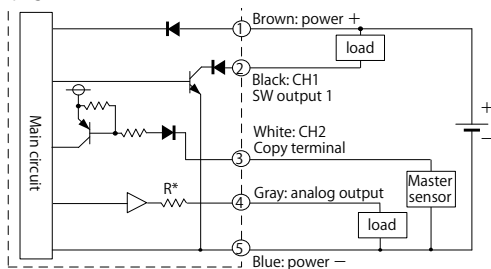

* Analog output voltage output type R: Approx. 1kΩ
Analog output current output type R: Approx. 100Ω

Main body connector

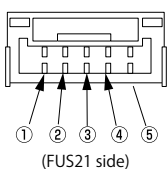

Pin No.	Line color	Contents
①	Brown	Power supply (+) (Voltage output: 12 to 24 V, current output: 24 V)
②	Black	CH1 (NPN transistor output1: max50mA)
③	White	CH2 (NPN transistor output: max50 mA or External input or Copy terminal)
④	Gray	Analog output Voltage output: 1 to 5 V load impedance 50 kΩ or over Current output: 4 to 20 mA load impedance 300Ω or less
⑤	Blue	Power supply (-) (GND)

● PNP Output

FUS21-PV / PA (1 analog, 2 switches)

Using CH2 as switch output

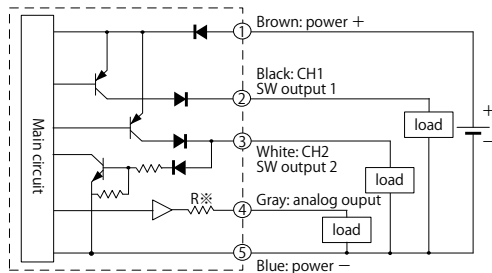

Using CH2 as external input

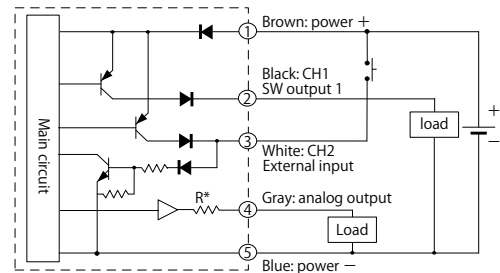

FUS21-PVC / PAC (1 analog, 1 switch, With copy function)

Model with the copy function

* When using the copy function, please refer to "Copying setting values" below.

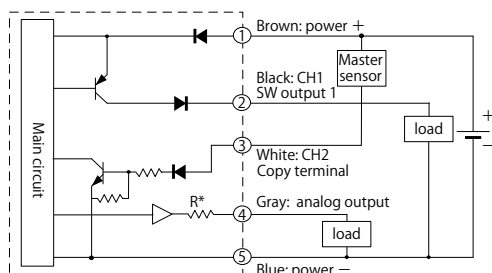

* Analog output voltage output type R: Approx. 1kΩ
Analog output current output type R: Approx. 100Ω

Main body connector

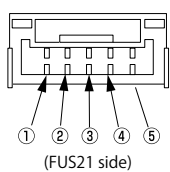

Pin No.	Line color	Content
①	Brown	Power supply (+) (Voltage output: 12 to 24 V, current output: 24 V)
②	Black	CH1 (PNP transistor output1: max50mA)
③	White	CH2 (PNP transistor output: max50 mA or External input or Copy terminal)
④	Gray	Analog output Voltage output: 1 to 5 V load impedance 50kΩ or over Current output: 4 to 20 mA load impedance 300Ω or less
⑤	Blue	Power supply (-) (GND)

● Copying setting values

FUS21-NVC / PVC / NAC / PAC (with copy function)

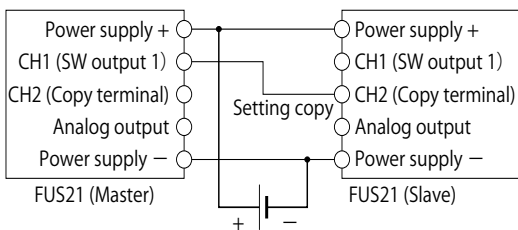

- Connect CH1 (SW output 1) on the master side and CH2 (copy terminal) on the slave side, turn on the sensor, and use the setting copy function (F.93). This connection shall be used only when using the setting copy function.
- Copying while a load is connected to CH1, or operating the sensor while CH1 and CH2 are connected, may cause unexpected behavior of the equipment or failure of the equipment or FUS21. Never use the FUS21 while it is connected to the copy terminal.
- For details of the copy setting function, refer to "F.93: Copy function" on page 29 of the Instruction Manual (full version).

Analog output characteristics

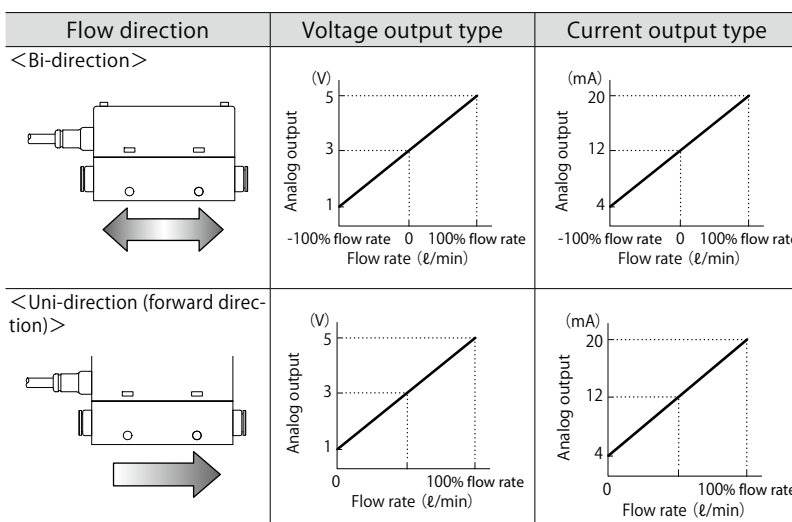

- The full scale is 0 to 100% for the uni-direction type, and -100% to 100% for the bi-direction type. The bi-direction type can be switched to uni-direction output with the button setting (forward and reverse directions). The value after switching is a reference value.
- For analog output when switched to carbon dioxide, select the output type from Type A or Type B.
 - Type A : Voltage output 1-3V (Uni-direction)
2-4V (Bi-direction)
Current output 4-12mA (Uni-direction)
8-16mA (Bi-direction)
 - Type B : Voltage output 1-5V, Current output 4-20mA
- Analog output is provided even outside the range of the measured flow rate range. Although the accuracy is not guaranteed, the lower limit of the voltage output type is approximately 0.6 V, and the upper limit is approximately 5.4 V. The lower limit of the current output type is approximately 2.4 mA, and the upper limit is approximately 21.6 mA.

Usage

⚠ Warning

- Before use, perform warm-up operation (at least for 5 minutes after energizing). Output accuracy is affected by self-heating due to energization in addition to temperature characteristics.
- Stop the equipment before changing the setting values. The control device may behave unexpectedly.
- Do not disassemble or modify the product.
- Observe the conditions of use for CE compliance.

This product is a CE compliant product that complies with the EMC Directive. The followings are mandatory conditions for compliance with the harmonized immunity standard EN 61000-6-2 applied to this product.

- (1). A cable with a pair of power lines and signal lines shall be used and evaluated as a signal line.
- (2). Surge immunity measures shall be implemented on the device side.

⚠ Caution

- Even if exceeding the flow rate range, analog output will be provided. "Hi" or "Lo" will be displayed, but please note beforehand that accuracy is not guaranteed.
- Avoid setting the switch in an area where the flow rate is not stable, such as in fluid pulsation. If switch operation is performed when the flow rate is not stable, the operation will become unstable. In this case, make sure that there is enough interval between the two setting values, or avoid setting the switch in an unstable area, and check that the switch operation is stable before use.
- Pay attention to the reverse current caused by disconnected wires/wiring resistance. If other devices, including other flow rate sensor, are connected to the same power supply as FUS21, and the switch output wire and power cable minus (-) side are short-circuited to check the operation of the control panel's input unit, or if the power cable's minus (-) side is disconnected, reverse current could flow to the flow rate sensor's switch output circuit and cause damage.

Take countermeasures as follows to prevent damages caused by reverse current.

- (1). Avoid concentrating current in the power supply line, especially the (-) side power supply line, and make the wiring as thick as possible.
 - (2). Limit the number of devices connected to the same power supply as the flow rate sensor.
 - (3). Place a diode in series with the flow sensor output line to prevent the current from flowing backwards.
 - (4). Place a diode in series with the power line (-) side of the flow sensor to prevent the current from flowing backwards.
- Do not press the display.
 - Since this product uses a micro-sensor chip, install it in a place where it will not be affected by drop shock or vibration. Also, handle the product as a precision component during installation and transportation.
 - If any abnormality occurs during operation, stop using the product immediately, turn off the power, and contact your dealer.
 - Immediately after energizing, the product does not perform any flow rate control operation for approx. 5 seconds, as self-diagnosis program runs. Use the control circuit and program that ignore signals for approx. 5 seconds after start-up.
 - When the power supply is shared between this product and an inductive load that generates surge current, such as a solenoid valve or relay, if the circuit is interrupted while the inductive load is operating, the surge current may flow around the output circuit and damage it, depending on the mounting position of the surge absorbing element. To prevent damage due to surge current wraparound, the following measures should be taken.
 - (1). Separate the power supplies for the output system, which is an inductive load such as solenoid valves and relays, and the input system such as flow rate controllers.
 - (2). If a separate power supply is not possible, install surge absorbing devices directly to all inductive loads; the surge absorbing devices connected to PLCs, etc. are intended to protect only that device.
 - (3). Connect a surge absorber to each part of the power wiring as shown in the figure below, and prepare for disconnection at unspecified points.

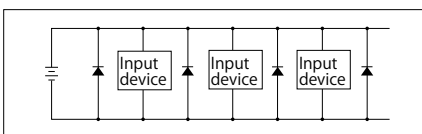
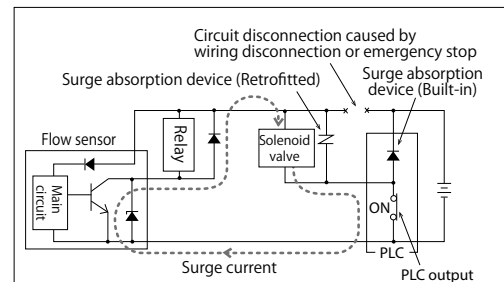
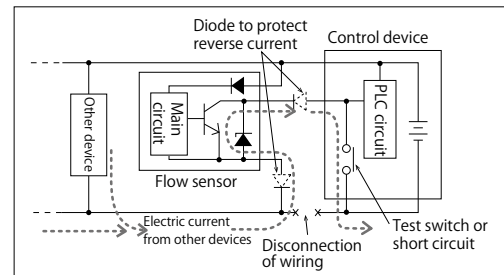

If devices are connected to the connector, turn off the power before disconnecting the connector. Disconnecting the connector while the power is on may cause surge current to circulate and damage the output circuit.

- For models with a needle valve, vibration may cause the needle to rotate, resulting in a change in flow rate.

● Names and functions of display and operation units

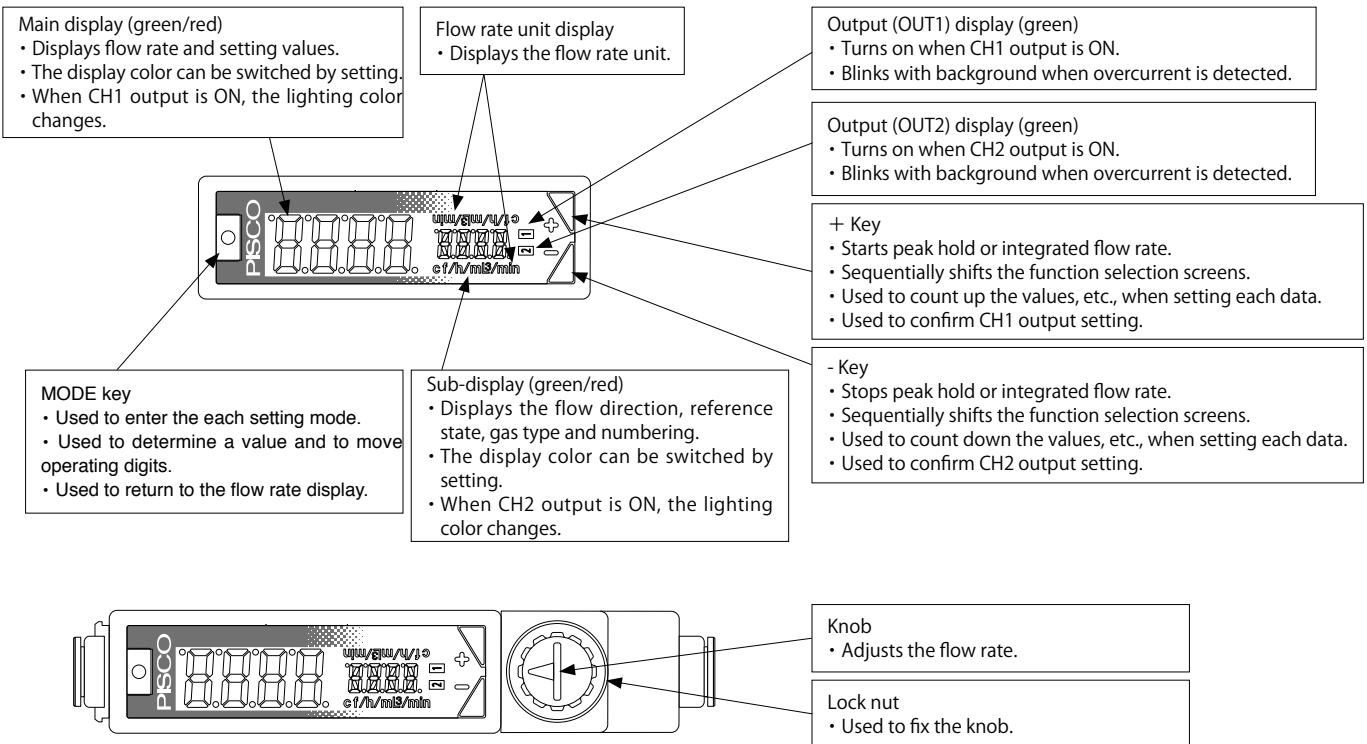

- The integrated flow rate value is displayed on the main display and sub display.
- When the display is inverted by "F.07: Display inversion setting", the main display and sub-display are inverted respectively. Please note that + key and - key operations are not replaced even when the display is inverted.
- When "F.05: Display Color Setting" is set to "ON Red / OFF Green" or "ON Green / OFF Red", the screen color will change when the switch output is ON. When CH1 is ON, the lighting color of the main display changes, and when CH2 is ON, the lighting color of the sub-display changes.

● Function Description

Some functions and settings can be completed when the normal flow is displayed, and others after entering the setting mode.

The setting mode is divided into SET mode and Maintenance mode based on the frequency of use.

To check the settings, the setting monitor mode is used.

< Normal mode (RUN mode) >

Item	Description	Factory setting
Instantaneous flow rate display	The instantaneous flow rate is displayed.	Display (Measurement)
Peak hold function	Max. and min. values for the flow rate within a set interval are displayed. There is a measurement/stop state, and the value is acquired in the measurement state. When the power is turned ON: Stop state	Non-display (Stop)
CO2 emission rate display	By setting the power, discharge pressure, flow rate of the compressor, as well as the power ⇔ CO2 conversion coefficient, you can learn how much CO2 is emitted (Calculated reference value). It can be used only when the gas type setting is "Air".	Non-display (Stop)
Integrated flow rate display	Displays the integrated flow rate. There are the measurement state/stop state, and the calculation of the integrated flow rate is performed in the measurement state. When the power is turned on, it is in the measurement state. In the switch output function, there is an integrated pulse function that turns the switch on and off at a set integrated value or higher, or outputs a pulse at every certain integrated value.	Non-display (Measurement)

< SET Mode >

No.	Item	Description	Factory setting
F.01	Selection of CH1 operation	Select the function of CH1. You can set switch output operation and set the integrated pulse.	No switch output
F.02	Selection of CH2 operation	Select the function of CH2. Select if CH2 is used as switch output or external input (integrated value reset / auto reference).	No switch output
F.03	Integrated functions setting	You can choose to acquire integrated flow rate values consecutively or at set times. You can also decide whether or not to save that data. (*)	Consecutive acquisition Data saving: OFF
F.04	Sub-screen display setting	Set the sub-display section's display method. It can be switched to "flow direction", "reference state", "gas type", or "numbering" display.	Flow direction
F.05	Display color setting	Set the display color (Red, Green). The display color when the switch output is ON can be set during normal display.	At normal display: Green At switch ON: Red
F.06	Flow rate direction setting (Bi-direction type only)	Set the flow direction. Setting is possible for bi-direction, one-side forward direction and one-side reverse direction.	Bi-direction
F.07	Display inversion function	The LCD display can be vertically inverted.	Standard display
F.08	Standard display setting	Select the standard state or reference state. Standard state (ANR): Flow rate converted to volume of 20° C, 1 atm and 65%RH. (For a gas type except for air is 20° C, 1 atm and 0%RH) Reference state (NOR): Flow rate converted to volume of 0° C, 1 atm and 0%RH.	ANR
F.10	Display cycle setting	The digital display refresh cycle can be set in three stages from 0.25s to 1s. If the display flicks, it may be improved by setting a longer display refresh cycle.	0.5sec
F.11	Analog output response time setting	Sets the response time. Response time can be set in seven stages from 0.05s to 1.5s. Chattering and mis-operation caused by sudden flow rate changes or noise are prevented.	0.05sec
F.12	Numbering setting	You can set the numbering.	0000
F.13	Gas type switching	The measured gas can be changed.	Air
F.14	ECO mode setting	ECO mode can be selected. If the buttons are not operated for approx. one minute, the ECO mode will activate and turn OFF the display's backlight. Current consumption can be reduced with this mode.	OFF
F.15	CO2 emission rate calculation setting	CO2 emission can be calculated. Set your compressor power, discharge pressure, discharge flow rate, and CO2 conversion coefficient.	Power: 0.2kW Pressure: 0.1MPa Flow rate: 100 ℓ/min Conversion coefficient: 0.000kg (CO ₂)/kWh
F.16	Lock setting	Key lock method and PIN number method can be set. Select according to the use purpose.	OFF
F.17	Peak hold setting	You can choose to acquire peak bottom values consecutively or at set times. You can also decide whether or not to save the data. (*)	Consecutive acquisition Data holding: OFF

*) Data is saved every 5 minutes. Please be careful so that the number of times the data is saved does not exceed the number of access to the storage element (the limit is 1 million times). (Changes in various settings are also counted in the accesses count.)

Saved times = Usage time / 5min (< 1 million times)

< Maintenance mode >

No.	Item	Description	Factory setting
F.91	Forced output function	Use this function to forcibly turn the switch output ON and confirm the wiring connection and initial operation of the input device.	—
F.92	Zero adjustment function	The zero point deviation is corrected. (Range: Within $\pm 10\%$ F.S.)	Adjusted value: 0 ℓ /min
F.93	Copy function	Operations and set values can be easily copied between two FUS21 with copy function. (Copying is only possible between products with the same model No.)	—
F.99	Reset function	Return the settings to the factory settings.	—

< Setting monitor mode >

Item	Description	Factory setting
Setting monitor function	The settings set in the SET mode can be checked. (The contents cannot be edited)	—
Model display function	Able to check the zero adjusted value, flow rate range, gas type, flow rate reference, flow direction, switch output type, and number of switch output points. (Current setting values, not factory setting, are displayed.)	—

Effect of setting changes

Performing a setting that changes the flow rate value (Table 1) will clear the setting for the function that refers to the flow rate value (Table 2). Perform settings for changing the flow rate value first, and then set the function to refer to the flow rate value. It will be cleared even when the setting is confirmed without any changes. To check the setting value, use the setting monitor mode.

Table 1:

Settings that change a flow rate value

No.	Item
F.06	Flow rate direction setting
F.08	Standard display setting
F.13	Gas type switching

Table 2: Function that refers to a flow rate value

No.	Item	Setting after clearing
F.01	Selection of CH1 operation	No switch output
F.02	Selection of CH2 operation	No switch output
—	Peak hold setting	Peak value bottom value: Reset, Measurement state: Stop
—	Integrated flow rate function	Integrated flow rate value: Reset Measurement state: Stop

● Switch output function

Depending on the application, you can choose from 8 types of switch operation.

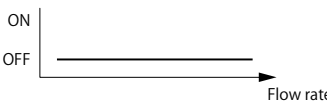
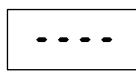
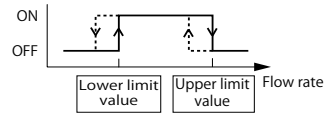
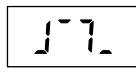
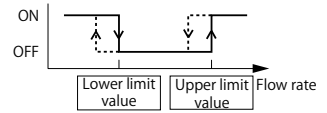
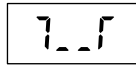
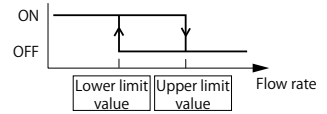
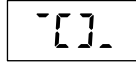
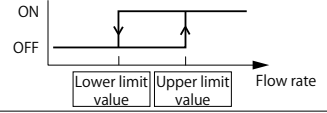
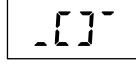
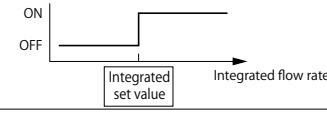
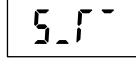
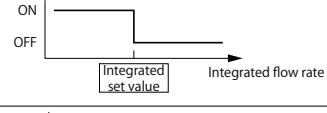
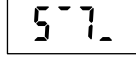
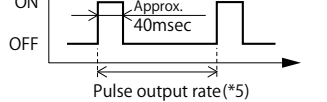
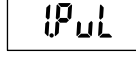
No.	Operation type	Description	Operating waveform	LCD display (Sub-display)
1	Switch operation OFF	Switch operation is in OFF state.		
2	Window operation (1) (ON within the range) (*1, *2, *3)	The switch output turns ON within the specified range.		
3	Window operation (2) (ON outside the range) (*1, *2, *3)	The switch output turns ON outside the specified range.		
4	Hysteresis operation (1) (ON at smaller flow rate side) (*1, *3)	The hysteresis can be set as desired, and the switch output turns OFF when the flow rate exceeds the specified value.		
5	Hysteresis operation (2) (ON at larger flow rate side) (*1, *3)	The hysteresis can be set as desired, and the switch output turns ON when the flow rate exceeds the specified value.		
6	Integrated output (1) (ON at setting value or higher) (*4)	The switch output turns ON at the set integrated flow rate or more.		
7	Integrated output (2) (OFF at setting value or higher) (*4)	The switch output turns OFF at the set integrated flow rate or more.		
8	Integrated pulse output (*5, *6)	Outputs an integrated pulse.		

*1) The settable range is 0 to 100% of the full scale flow rate.

*2) Hysteresis can be set for the upper and lower limit values of the window operation (1) and (2). The hysteresis can be set from 1 to 8% F.S.

*3) If the setting is made so that the lower limit setting value > the upper limit setting value, the upper and lower limit values will be automatically set interchangeably.

*4) The display range of integrated flow rate is the settable range.



*5) For pulse output rate, refer to "Pulse output rate" in "Specifications" on page 4.

*6) During integrated pulse output, the output display (OUT1, 2) blinks in accordance with the pulse output.

● Auto-reference function

The auto-reference function takes in the flow rate being measured and sets it as the threshold for the switch output. This function uses the button operation or the external input of CH2 to take in the flow rate and output from CH1. When the threshold value of the switch changes due to a change in work-piece, the threshold value can be changed automatically.

■ How to take in the flow rate by button operation

- 1-point input: Press and hold the  key for 2 seconds to take in the instantaneous flow rate at the time.
- 2-point input: Press and hold the  key for 2 seconds to take in the instantaneous flow rate at the time as the upper limit value.
Press and hold the  key for 2 seconds to take in the instantaneous flow rate at the time as the lower limit value.

■ How to read the flow rate by external input

- 1-point input: When the external output is ON (40 msec. Save), takes in the instantaneous flow rate at the time.
- 2-point input: When the external output is ON (40 msec. Save), takes in the instantaneous flow rate at the time. The upper and lower limit values are automatically determined by comparing the size relationship of the two most recent points.





(Ex.)

Taken in value (mℓ/min)		Lower limit value (mℓ/min)	Upper limit value (mℓ/min)
Initial value		0	0
1st	123	0	123
2nd	234	123	234
3rd	45	45	234
4th	345	45	345
5th	456	345	456
6th	-50	-50	456
7th	-211	-211	-50
8th	-100	-211	-100
9th	-300	-300	-100
10th	0	-300	0

The initial value is zero both in the upper and lower limits.

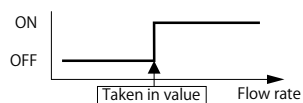
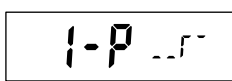
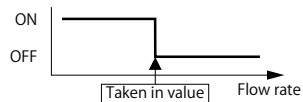
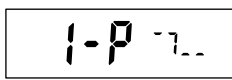
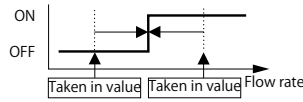
- While "F.02: CH2 operation setting" is set to "Auto-reference", "F.01: CH1 Operation setting" is disabled and no operation is possible. When setting "F.01: CH1 Operation setting", set "F.02: CH2 operation setting" to other than "Auto-reference".
- Taking in the flow rate by the button operation is possible only during instantaneous flow rate display. Doing so by the external input is possible during RUN display.
- The values taken in by auto-reference are cleared when the power is turned OFF. Perform setting again.
- After taking in the flow rate, obtained values are displayed.
- The values taken in by auto-reference can be checked also in the setting monitor mode.
- For external input, ON/OFF pulse is output from CH1 as the taking-in check when taking in the flow rate.
- While pressing and holding the  key for 1 second, the taken in values can be displayed (only when taking in the flow rate by external input).

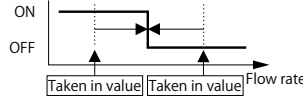
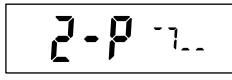
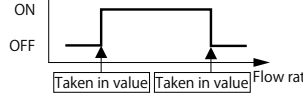
Auto-reference function

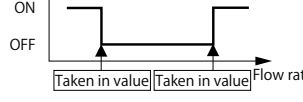
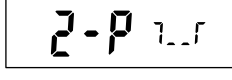
No. of input pts	Operation type	Description	Operating waveform	LCD display
1 point (1-P)	ON at taken in value or above	The switch output turns ON at the taken in flow rate or more. (Threshold: Taken in value)		
	OFF at taken in value or above	The switch output turns OFF at the taken in flow rate or more. (Threshold: Taken in value)		
2 point (2-P)	ON at or above the center of two points	The switch output turns ON at or above the center value of 2 flow rates taken in. (Threshold: $\frac{\text{Taken in value}① + \text{Taken in value}②}{2}$)		
	OFF at or above the center of two points	The switch output turns OFF at or above the center value of 2 flow rates taken in. (Threshold: $\frac{\text{Taken in value}① + \text{Taken in value}②}{2}$)		
	ON between 2 points	The switch output turns ON between 2 flow rates taken in. (Threshold①: Taken in value①) (Threshold②: Taken in value②)		
	OFF between 2 points	The switch output turns OFF between 2 flow rates taken in. (Threshold①: Taken in value①) (Threshold②: Taken in value②)		

Flow sensor selection

Please utilize this section as a guide for selecting a flow rate range when using a flow sensor for suction/ release verification with a suction nozzle, leakage test, etc.

Flow rates can be calculated with the effective sectional area of the nozzle (pinhole) and the pressure difference inside and outside of the nozzle.

When $P_1 \geq 1.89P_2$ (sonic)

$$Q = 113.2 \times S \times P_1$$

When $P_1 < 1.89P_2$ (subsonic)

$$Q = 226.4 \times S \times \sqrt{P_2(P_1 - P_2)}$$

Q : Flow rate ℓ/min

P_1 : Absolute pressure at primary side MPa

P_2 : Absolute pressure at secondary side MPa

S : Effective sectional area of the nozzle (pinhole) mm²

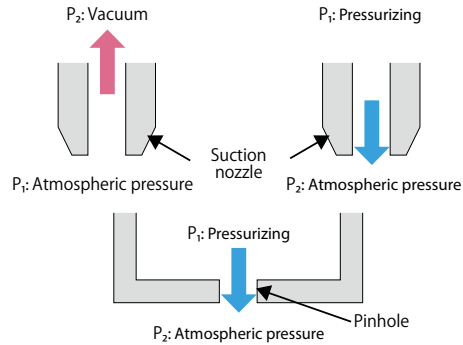

● Calculation example

The calculated flow rates with a nozzle diameter of $\phi 0.1 - \phi 2$ and variable P_2 are shown in the table below.

	P_1 (MPa) Absolute pressure	P_1 (MPa) Gauge pressure	P_2 (MPa) Absolute pressure	P_2 (MPa) Gauge pressure	Sonic/ Subsonic	Calculated flow rates (ℓ/min[ANR])								
						$\phi 0.1$	$\phi 0.2$	$\phi 0.3$	$\phi 0.4$	$\phi 0.5$	$\phi 0.7$	$\phi 1$	$\phi 1.5$	$\phi 2$
Suction	0.1013	0	0.0313	-0.07	Sonic	0.090	0.360	0.810	1.440	2.250	4.411	9.002	20.254	36.007
	0.1013	0	0.0413	-0.06	Sonic	0.090	0.360	0.810	1.440	2.250	4.411	9.002	20.254	36.007
	0.1013	0	0.0513	-0.05	Sonic	0.090	0.360	0.810	1.440	2.250	4.411	9.002	20.254	36.007
	0.1013	0	0.0613	-0.04	Subsonic	0.088	0.352	0.792	1.408	2.200	4.312	8.800	19.801	35.202
	0.1013	0	0.0713	-0.03	Subsonic	0.082	0.329	0.740	1.315	2.055	4.028	8.220	18.494	32.878
	0.1013	0	0.0813	-0.02	Subsonic	0.072	0.287	0.645	1.147	1.792	3.512	7.166	16.125	28.666
	0.1013	0	0.0913	-0.01	Subsonic	0.054	0.215	0.483	0.859	1.343	2.631	5.370	12.083	21.480
Blow (leakage test)	0.1113	0.01	0.1013	0	Subsonic	0.057	0.226	0.509	0.905	1.414	2.772	5.657	12.727	22.626
	0.1213	0.02	0.1013	0	Subsonic	0.080	0.320	0.720	1.280	2.000	3.920	8.000	17.999	31.998
	0.1413	0.04	0.1013	0	Subsonic	0.113	0.453	1.018	1.810	2.828	5.543	11.313	25.454	45.252
	0.1613	0.06	0.1013	0	Subsonic	0.139	0.554	1.247	2.217	3.464	6.789	13.856	31.175	55.423
	0.1813	0.08	0.1013	0	Subsonic	0.160	0.640	1.440	2.560	4.000	7.840	15.999	35.998	63.996
	0.2013	0.1	0.1013	0	Sonic	0.179	0.716	1.610	2.862	4.472	8.765	17.888	40.248	71.552
	0.3013	0.2	0.1013	0	Sonic	0.268	1.071	2.410	4.284	6.694	13.119	26.774	60.242	107.096
	0.4013	0.3	0.1013	0	Sonic	0.357	1.426	3.209	5.706	8.915	17.474	35.660	80.236	142.641
	0.5013	0.4	0.1013	0	Sonic	0.445	1.782	4.009	7.127	11.137	21.828	44.547	100.230	178.186
	0.6013	0.5	0.1013	0	Sonic	0.534	2.137	4.809	8.549	13.358	26.182	53.433	120.224	213.731

*1. Flow rates could be larger than the calculated values if there is a leak in piping, etc. Please take account of the piping leak rate when selecting the flow rate.

*2. Flow rates could be smaller than the calculated values since the flow rates get limited if there is a section in piping that is narrower than the diameter of the suction nozzle. In such cases, suction verification, etc. may not be performed either.

*3. The Effective sectional area is a mere guideline. With a slender nozzle, the effective section will be smaller than the opening of the nozzle.

*4. The response speed is determined by the inner volume of the piping from the flow sensor to the suction nozzle (pinhole). When performing high-speed detection, try to reduce the volume as much as possible by taking measures such as mounting the flow sensor close to the suction nozzle.

Suction verification

1. Response time

The Response time during suction verification is determined by the inner volume of the piping and the exhaust speed of the vacuum pump, etc.

For example, dependence of response time on piping in the case of piping arrangement on the right is shown below. Based on these results, the effective way to shorten the response time is to minimize the inner volume of the piping from the sensor to the suction nozzle.

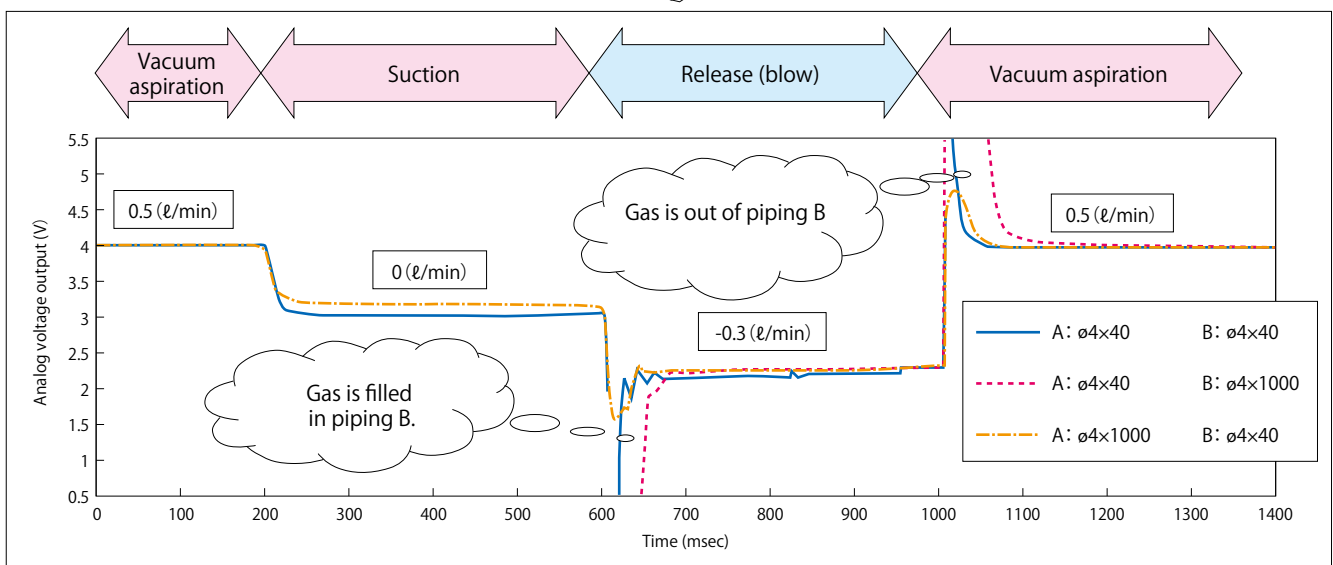
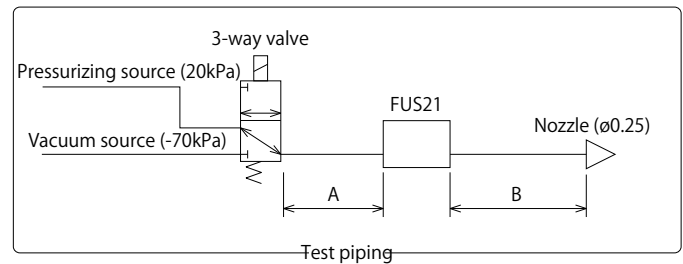

Dependence of response time on piping

2. Collet nozzles

A collet nozzle is often used when the workpiece to be suctioned should not be in direct contact with the nozzle. Its inside is pyramid shaped, and when the workpiece is suctioned, leakage occurs since it structurally leaves gaps in the four corners. If the effective sectional area of the piping (including valves, fittings, etc.) is smaller than the gaps between the collet nozzle and the workpiece (the effective sectional area), and then because the flow rate is determined by the effective sectional area of the piping, the difference between the flow rate with suction and the flow rate without suction becomes small and hard to detect. In such cases, make the effective sectional area of the piping much bigger than that of the gaps between the collet nozzle and the workpiece so that suction can be verified surely.

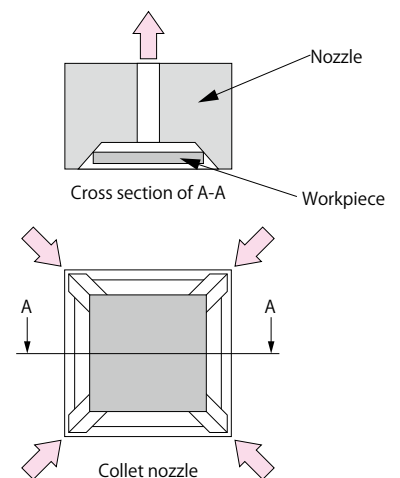

Leakage test

1. Leakage calculation

Please make use of this leakage calculation when replacing the pressure calculation.

$$Q = V \times \frac{\Delta P}{1.013 \times 10^5} \times \frac{60}{T}$$

Q: Leak rate (mℓ/min (ANR)) ΔP: Differential pressure (Pa) V: Inner volume of workpiece (mℓ) T: Detection time (s)

(Ex.) When a differential pressure of 20 Pa is generated in 5 seconds of detection time with a workpiece of 500 ml inner volume, the leak rate is:

$$Q = 500 \times \frac{20}{1.013 \times 10^5} \times \frac{60}{5} \doteq 1.18 \text{ (mℓ/min (ANR))}$$

Measurement principle

2-color Dual Display Flow Sensor 21 has adopted the platinum sensor chip applied with a silicon micromachining technology. The Sensor part is thermally insulated from the silicon substrate, and its heat capacity is extremely small, enabling high-speed response and high sensitivity. Two temperature sensors are set at opposite sides of the heater at the sensor part. Platinum, which changes resistance value by temperature, is used for temperature sensors. When the heater is energized and there is no flow, temperature distribution is symmetrical about an axis of heater. With flow, symmetrical distribution is broken, and the upstream temperature drops and the downstream temperature rises. This temperature difference is reflected upon and indicated in the difference between resistance values of the temperature sensors and would fluctuate with flow rates. When the flow direction is reversed, the temperature difference (resistance value difference) will be reversed. By using this method, bi-directional flow rates can be detected. It is suitable for detecting relatively small flow rates.

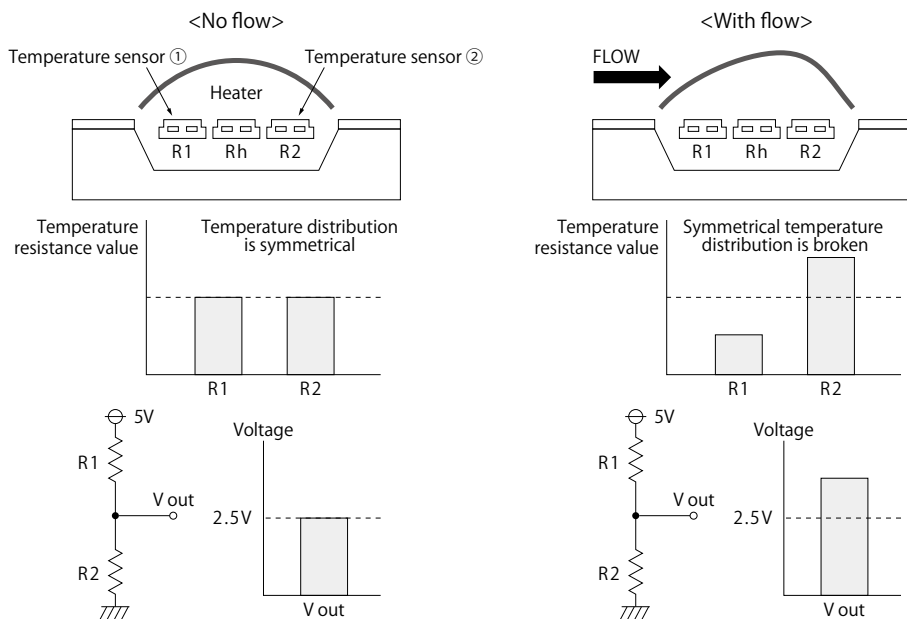

PISCO®

<input type="checkbox"/> OVERSEAS SALES DEPARTMENT (HQ)	TEL. +81-(0)265-76-7751	FAX. +81-(0)265-76-3305	e-mail. intl@pisco.co.jp
<input type="checkbox"/> PISCO TAIWAN CO., LTD.	TEL. +886-(0)6-726-5762	FAX. +886-(0)6-726-5752	e-mail. P8638@ms16.hinet.net
<input type="checkbox"/> NIHON PISCO TAIWAN CO., LTD	TEL. +886-(0)6-726-4520	FAX. +886-(0)6-726-1526	
<input type="checkbox"/> PISCO USA, INC.	TEL. +1-630-993-3500		e-mail. info@pisco.com
<input type="checkbox"/> PISCO KOREA CO., LTD	TEL. +82-32-327-9795	FAX. +82-32-327-0385	e-mail. webmaster@pisco.co.kr
<input type="checkbox"/> PISCO VIETNAM CO., LTD	TEL. +84-24-3200-0310	FAX. +84-24-3200-5331	e-mail. piscovn@pisco-vn.com
<input type="checkbox"/> NIHON PISCO CO., LTD. SHANGHAI REPRESENTATIVE OFFICE	TEL. +86-21-31332623		e-mail. ribenpisco@gmail.com
<input type="checkbox"/> NIHON PISCO CO., LTD. BANGKOK REPRESENTATIVE OFFICE	TEL. +66-(0)2-612-7366	FAX. +66-(0)2-612-7399	e-mail. piscobkk@pisco.co.jp

