



New  
Line Up

## Vacuum Filter for Various Vacuum Piping Vacuum Filter Series

- *Dusts and drains are removed by cyclone effect and element. (Large Capacity Union Type: VFB and VFR)*
  - *Large dust case reduces maintenance frequency. (Large Capacity Union Type: VFR)*
- *Dusts are not scattered by easy detachment of dust case. (Large Capacity Union Type: VFB)*
  - *Small vacuum filter is suitable for a high-cycle vacuum operation. (Small Union Type: VFU0&1)*
- *There are 2 selections of element size depending on dust size or exchange period of the element. (Small Union Type: VFU1)*
- *Plug-in type with filter. PP material achieves a low price. (Plug-in Type: VFJ)*
- *Selections (VFU1,2,3) added for "Copper alloy free" and "low ozone measure".*

No copper based metal for metal parts and HNBR for seal rubber.

## Vacuum Filter Series

VACUUM GENERATOR

EXTERNAL VACUUM CONTROLLER

VACUUM PAD

VACUUM ACCESSORIES

### Model Designation for Large Capacity Union Type: VRB and VFR (Example)

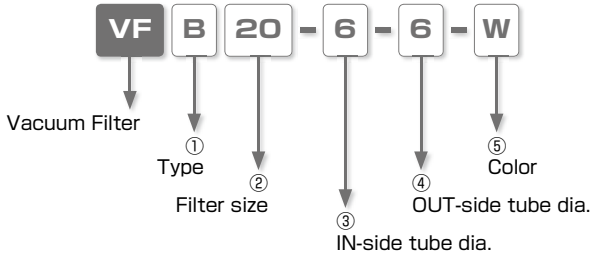

#### ① Type

Code	<b>B</b>	<b>R</b>
Type	Large Capacity Union Type for Vacuum Circuit	Large Capacity Union Type for Exhaustion

#### ② Filter size

Code	<b>20</b>
Filter area	20cm <sup>2</sup>

#### ③ IN-side tube dia.

Code	<b>6</b>	<b>8</b>	<b>10</b>	<b>12</b>	<b>16</b>
Tube dia.	ø6mm	ø8mm	ø10mm	ø12mm	ø16mm

#### ④ OUT-side tube dia.

Code	<b>6</b>	<b>8</b>		<b>12</b>	<b>16</b>	<b>No code</b>
Tube dia.	ø6mm	ø8mm	ø10mm	ø12mm	ø16mm	Large Capacity Union Type for Exhaustion (VFR)

#### ⑤ Color

Code	<b>W</b>	<b>No code</b>
Color	Light-gray	Black

### Model Designation for Plug-in Type: VFJ (Example)

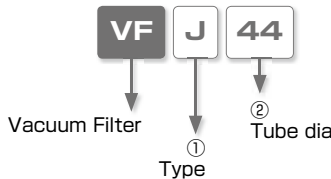

#### ① Type

Code	<b>J</b>
Type	Plug-in

#### ② Tube dia

Code	<b>33M</b>	<b>44</b>	<b>66</b>	<b>1/8-1/8M</b>
Tube dia.	ø3mm	ø4mm	ø6mm	ø3.2mm

### ■ Model Designation for Union Type: VFU (Example)

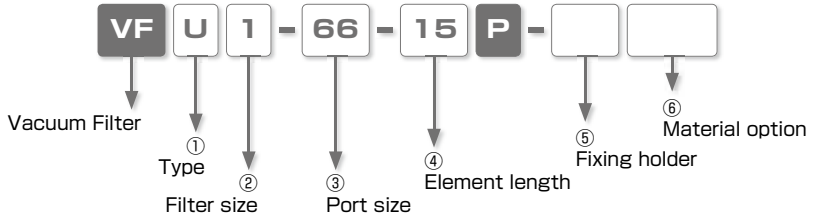

#### ① Type

Code	U
Type	Small Union

#### ② Filter size

Code	0	1	2	3	
Filter area	1.4cm <sup>2</sup>	2.8cm <sup>2</sup> (Element length : 15mm)	4.7cm <sup>2</sup> (Element length : 25mm)	7.5cm <sup>2</sup>	12.5cm <sup>2</sup>

#### ③ Port size

Joint type	Push-In Fitting						Metric thread		
	Code	180180*	33*	44	66	88	1010	M3M3*	55
Port size		ø1.8mm	ø3mm	ø4mm	ø6mm	ø8mm	ø10mm	M3×0.5	M5×0.8

※ . \* markings are for VFU0 type only.

#### ④ Element length (Selectable for only ② Filter size code: 1)

Code	15	25
Element length	15mm	25mm

#### ⑤ Fixing holder

Code	No code	NH
Holder	with Fixing holder	without Fixing holder

#### ⑥ Material option

Code	No code	-S3
Material	Standard	Copper alloy free material
Filter size	All filter size	VFU1, VFU2, VFU3

※ . This option is not available for ③ Port size ø3mm.

### ■ Model Designation for Pad Direct Mounting Type: VFF (Example)

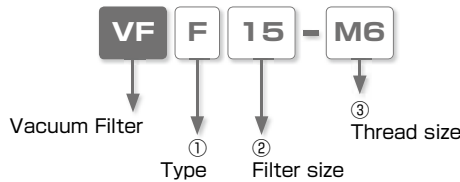

#### ① Type

Code	F
Type	Pad Direct Mounting

#### ② Filter size

Code	15	30
Filter area	1.7cm <sup>2</sup>	7cm <sup>2</sup>

#### ③ Thread size

Code	M4	M6
Thread size	M4×0.7	M6×1

## Vacuum Filter Series

VACUUM GENERATOR  
 EXTERNAL VACUUM CONTROLLER  
 VACUUM PAD  
 VACUUM ACCESSORIES

### Specifications

Type	VFR	VFB	VFU0	VFU1	VFU2	VFU3	VFF	VFJ
Fluid medium	Air							
Operating pressure range	-100 ~ 0kPa							
Filtering accuracy	10μm							
Operating temp. range	0 ~ 60°C (No freezing)							
Filter area	20cm <sup>2</sup>	1.4cm <sup>2</sup>	2.8cm <sup>2</sup> *1	7.5cm <sup>2</sup>	12.5cm <sup>2</sup>	1.7cm <sup>2</sup> *3	0.8cm <sup>2</sup> *5	
			4.7cm <sup>2</sup> *2			7cm <sup>2</sup> *4	1.1cm <sup>2</sup> *6	

\*1. Element length: 15mm    \*2. Element length: 25mm    \*3. Filter size: 15mm  
 \*4. Filter size: 30mm    \*5. Port size: 33M, 44, 1/8-1/8M    \*6. Port size: 66

### Construction (VFU1 type)

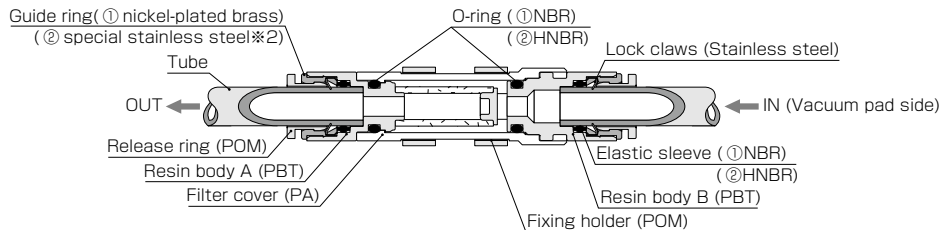

※ 1. The above ① is standard material and ② is copper alloy free material.  
 ※ 2. Equivalent Anti-Corrosive Level to SUS303

### Piping Arrangement Example

Place a vacuum filter between vacuum generator and vacuum pad in order to filter out dusts and prevent damage to vacuum generator.

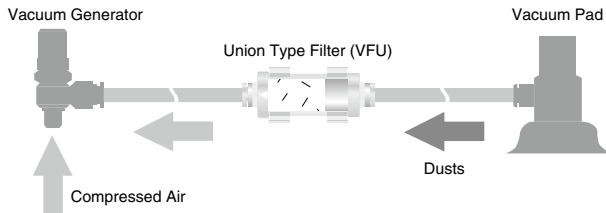

Large Capacity Union Type for Exhaustion "VFR" is to be installed on the exhaust side of Vacuum Generator VRL conveying tiny work-pieces like granule and powder.

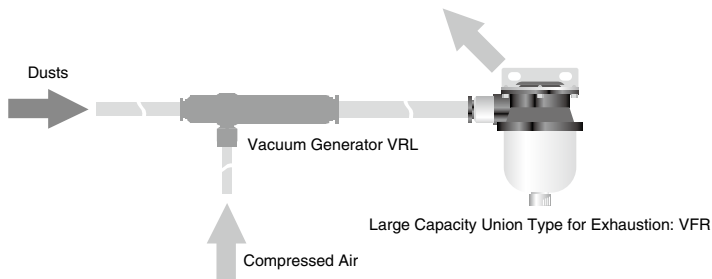

## How to insert and disconnect

### 1. How to insert and disconnect tubes (Push-In Fitting)

#### ① Tube insertion

Insert a tube into Push-In Fitting up to the tube end. Lock-claws bite the tube and fix it automatically, then the elastic sleeve seals around the tube. Refer to "2. Instructions for Tube Insertion" under "Common Safety Instructions for Fittings" .

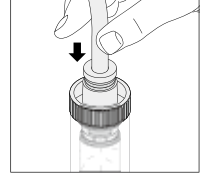

#### ② Tube disconnection

The tube is disconnected by pushing release-ring to release Lock-claws. Make sure to stop air supply before the tube disconnection.

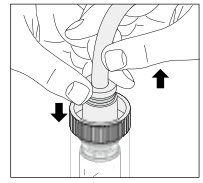

### 2. How to fix body

#### ① Large Capacity Union

Type: VFB

Fix the body with M5 screws. Refer to the dimensional drawings for the hole pitch.

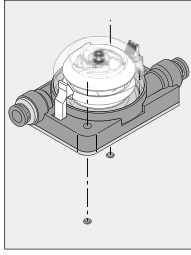

#### ② Large Capacity Union

Type for Exhaustion: VFR

Use 2 holes on bracket to fix the body with M5 screws. Refer to the dimensional drawings for the hole pitch.

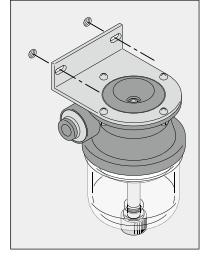

#### ③ Small Union Type, Union Type: VFU

Use 2 holes on the fixing holder to fix the body with screws below. Refer to the dimensional drawings for the hole pitch.

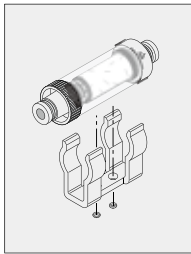

VFU1: M3 outersunk screw

VFU2, 3: M4 screw

#### ④ Pad Direct Mounting

Type: VFF

Attach VFF filter between a vacuum pad holder and a vacuum pad. Tighten metric male and female threads with a proper tool. Refer to the recommended tightening torque listed below and the dimensional drawings for thread size.

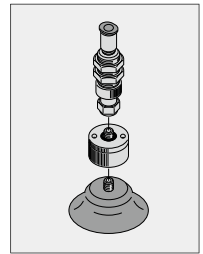

● Table: Recommended tightening torque

Thread size	Tightening torque
M4×0.7	0.5 ~ 0.6N·m
M6×1	1.5 ~ 2N·m

## Vacuum Filter Series

VACUUM GENERATOR

EXTERNAL VACUUM CONTROLLER

VACUUM PAD

VACUUM ACCESSORIES

### Pressure Loss Chart

Large Capacity Union Type: VFB

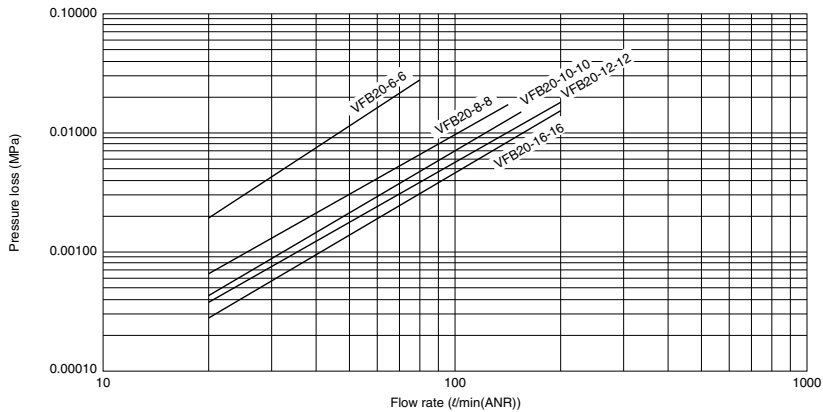

Large Capacity Union Type: VFR

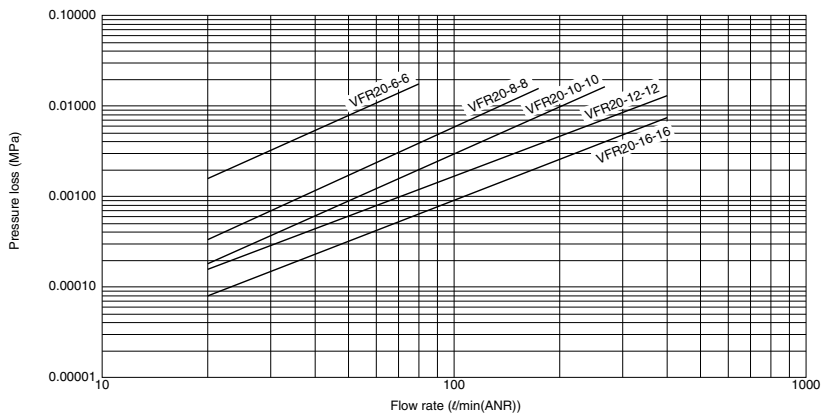

Union Type: VFUO

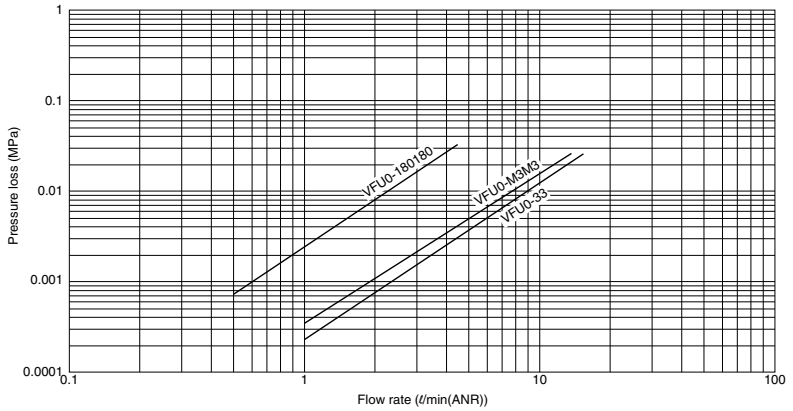

Union Type: VFU1,2,3

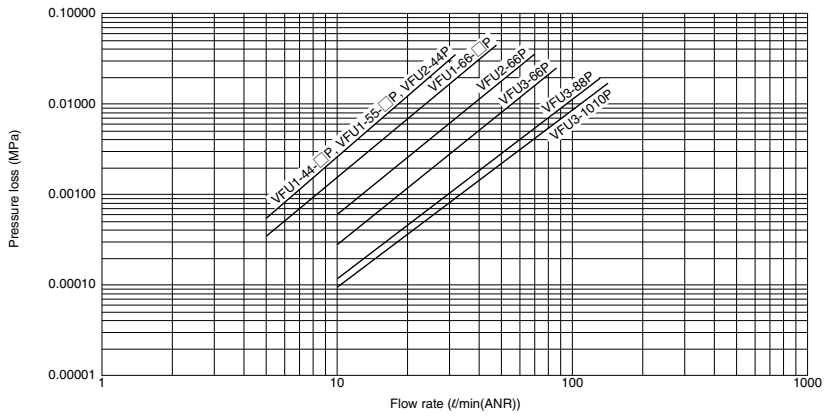

Plug-in Type: VFJ

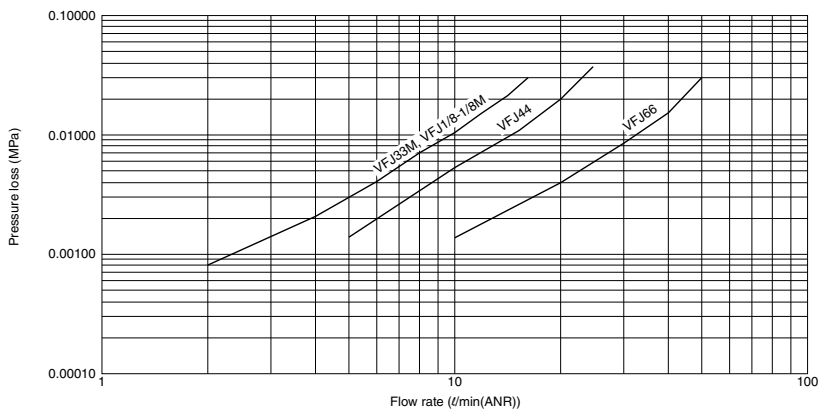

## Vacuum Filter Series

## ⚠ Detailed Safety Instructions

Before using PISCO products, be sure to read "Safety Instructions" and "Safety Instruction Manual" on page 35-39 and "Common Safety Instructions for Vacuum Series" on page 47-49.

## Warning

1. Do not supply positive pressure to VFB and VFR (Large Capacity Union Type). They are not an explosive-proof structure. Since their pressure resistance is low, there is a possibility of personal injury due to damage to the product.
2. (Small) Union Type "VFU" and Plug-in Type "VFJ" are the filters for vacuum. Do not keep applying positive pressure to the products continuously. Since the filters are not explosive-proof structure, there is a possibility of personal injury due to damage to the product.
3. Please carry out the maintenance of filter element periodically. There is a possibility of dropping the performance or causing troubles by clogging on the element. Thoroughly read "Replacement of Filter" in the catalog. Before replacing the filter element, make sure to release pressure and remain atmospheric pressure condition in the filter. Filter element of VFJ is not replaceable.
4. PP material of VFJ can be deteriorated by being exposed to direct sunlight or ultraviolet rays. When it is operated under chemical environment or touches chemicals, please refer to "Chemical-proof properties" in PISCO website and confirm the influence of chemicals to the materials.

## Caution

1. Refer to Caution 9 in "Common Safety Instructions for Vacuum Series" for use environment of Vacuum Filter.
2. Please confirm the direction of IN and OUT marked on the product, when Vacuum Filter is attached to tube. Filter function does not work properly by an opposite direction of attachment.
3. Cover the filter case properly and be sure that there is no vacuum leakage after removing dusts or replacing filter element.
4. Connect nipple side of Plug-in Type "VFJ" with vacuum generator port and Push-In Fitting side with work-piece port. Opposite direction of installation is also usable, but filter area becomes smaller and the clogging condition can not be observed.
5. When tube is inserted into Push-In Fitting of Plug-in Type "VFJ", avoid an excessive force to insert. Otherwise, there is a possibility of damaging filter inside.

## ■ Applicable Tube and Related Products

## Polyurethane Tube

(1. Piping products catalog P.596)

- Polyurethane Tube is for general pneumatic piping and suitable for piping compactly.

## Nylon Tube

(1. Piping products catalog P.608)

- Nylon Tube is for general pneumatic piping and suitable for a high-pressure fluid medium up to 1.5MPa (NB tube: 1.0MPa).

## Vacuum Tube

(1. Piping products catalog P.612)

- Vacuum Tube is a ultra-soft tube and suitable for piping vacuum generators or actuators.

Vacuum Generators . . . . . P.52

Vacuum Generator VRL . . . P.304

## Vacuum Pad Series

- Vacuum Pad Standard Serie . . . . . P.428
- Vacuum Pad Sponge Series . . . . . P.468
- Vacuum Pad Bellows Series . . . . . P.488
- Vacuum Pad Multi-Bellows Series . . . . . P.508
- Vacuum Pad Oval Series . . . . . P.526
- Vacuum Pad Soft Series . . . . . P.550
- Vacuum Pad Soft Bellows Series . . . . . P.578
- Vacuum Pad Skidproof Series . . . . . P.604
- Vacuum Pad Ultrathin Series . . . . . P.624
- Vacuum Pad Mark-free Series . . . . . P.642
- Vacuum Pad Long Stroke Series . . . . . P.658



## Standard Size List

### Large Capacity Union Type (Filter area: 20cm<sup>2</sup>)

Type	Page	Vacuum port	Exhaust port				
			6mm	8mm	10mm	12mm	16mm
VFB Tube exhaust	767	6mm	●				
		8mm		●			
		10mm			●		
		12mm				●	
		16mm					●

Type	Page	Vacuum port	Exhaust port				
			6mm	8mm	10mm	12mm	16mm
VFR Tube exhaust	768	6mm	●				
		8mm		●			
		10mm			●		
		12mm				●	
		16mm					●

Type	Page	Vacuum port	Exhaust port				
VFB Open-air exhaust	768	6mm			●		
		8mm			●		
		10mm			●		
		12mm			●		
		16mm			●		

### Union Type (Filter area "VFU0" : 1.4cm<sup>2</sup> / "VFU1" : 2.8cm<sup>2</sup>, 4.7cm<sup>2</sup> / "VFU2,3" : 7.5cm<sup>2</sup>, 12.5cm<sup>2</sup>)

Type	Page	Vacuum port	Exhaust port					
			1.8mm	3mm	4mm	6mm	M3×0.5	M5×0.8
VFU Small Union Type 0, 1	770	1.8mm	●					
		3mm		●				
		4mm			●			
		6mm				●		
		M3×0.5					●	
		M5×0.8						●

Type	Page	Vacuum port	Exhaust port			
			4mm	6mm	8mm	10mm
VFU Union Type 2, 3	772	4mm	●			
		6mm		●		
		8mm			●	
		10mm				●

### Pad Direct Mounting (Filter area: 1.7cm<sup>2</sup>, 7cm<sup>2</sup>)

Type	Page	Vacuum port	Exhaust port	
			M4×1	M6×1
VFB	774	M4×1	●	
		M6×1		●

### Plug-in Type (Filter area: 0.8cm<sup>2</sup>, 1.1cm<sup>2</sup>)

Type	Page	Vacuum port	Exhaust port			
			3mm	4mm	6mm	1/8
VFU	774	3mm	●			
		4mm		●		
		6mm			●	
		1/8				●

## Vacuum Filter Series

VACUUM GENERATOR

EXTERNAL VACUUM CONTROLLER

VACUUM PAD

VACUUM ACCESSORIES

### VFB Large Capacity Union Type (Tube exhaust)



RoHS compliant

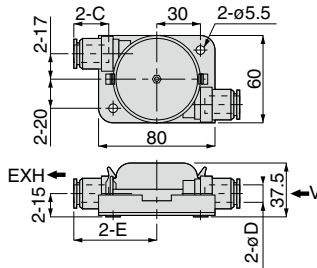
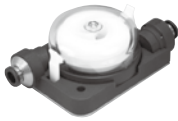

Unit : mm

Model code	Tube O.D. øD	C	E	Filter area (cm <sup>2</sup> )	Weight (g)	CAD file name
VFB20-6-6-□	6	17	52.6	20	208	VGF-001
VFB20-8-8-□	8	18.2	53.9		207	
VFB20-10-10-□	10	20.7	54.8		201	
VFB20-12-12-□	12	23.3	57.4		198	
VFB20-16-16-□	16	24.8	63.8		215	

※ Fill in □ in Model code with "W" for body color : light-gray.

※ Replacement Filter Element model code : VFE20

## Replacement Element

767

Small Vacuum Regulator

Auto Box of Controller

Vacuum Filter

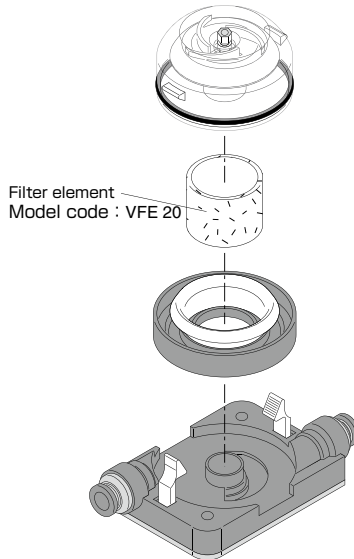

## VFR Large Capacity Union Type (Tube exhaust)



RoHS compliant

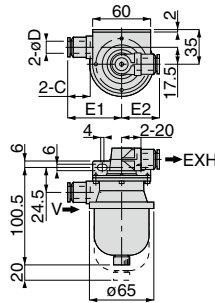

Unit : mm

Model code	Tube O.D. øD	C	E1	E2	Filter area (cm <sup>2</sup> )	Weight (g)	CAD file name
VFR20-6-6-□	6	17	44.1	34.1		245	VGF-002
VFR20-8-8-□	8	18.2	45.4	35.4		244	
VFR20-10-10-□	10	20.7	46.3	36.3	20	238	
VFR20-12-12-□	12	23.3	48.9	38.9		234	
VFR20-16-16-□	16	24.8	55.3	45.3		252	

※ Fill in □ in Model code with "W" for body color : light-gray.

※ Replacement Filter Element model code : VFE20

## VFR Large Capacity Union Type (Open-air exhaust)



RoHS compliant

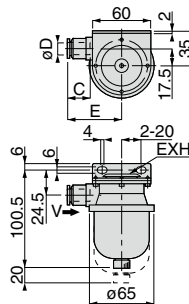

Unit : mm

Model code	Tube O.D. øD	C	E	Filter area (cm <sup>2</sup> )	Weight (g)	CAD file name
VFR20-6-□	6	17	44.1		206	VGF-003
VFR20-8-□	8	18.2	45.4		206	
VFR20-10-□	10	20.7	46.3	20	202	
VFR20-12-□	12	23.3	48.9		201	
VFR20-16-□	16	24.8	55.3		209	

※ Fill in □ in Model code with "W" for body color : light-gray.

※ Replacement Filter Element model code : VFE20

## Vacuum Filter Series

## ■ Replacement of Element

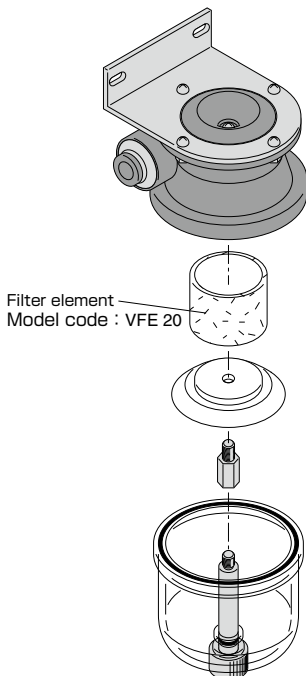
VACUUM  
GENERATOREXTERNAL VACUUM  
CONTROLLERVACUUM  
PADVACUUM  
ACCESSORIES



## Vacuum Filter Series

VACUUM GENERATOR

EXTERNAL VACUUM CONTROLLER

VACUUM PAD

VACUUM ACCESSORIES

### Replacement of Filter Element: Small Union Type

- ① Turn fitting body to the direction of "O" marked on filter cover by 45 degrees.  
(Turn fitting body to the direction of "L" marked on filter cover until it locks after filter replacement)

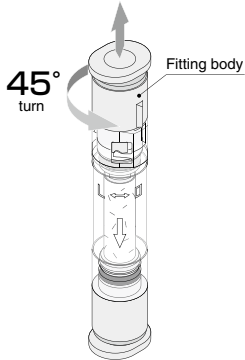

- ② Take out the fitting body from the filter cover and replace filters. Insert Joint Part of fitting body into the filter up to half and combine with fitting body A (refer to page 770). Pay attention not to squash Filter Edge.

Note 1) There are two types of filter element (15mm and 25mm). Select the suitable one before the replacement.

Note 2) Assemble the vacuum filter properly after the replacement by reversing the procedure mentioned above.

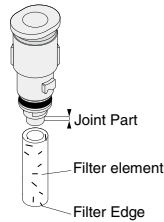

# VFU Union Type



RoHS compliant

Copper alloy free  
Selectable

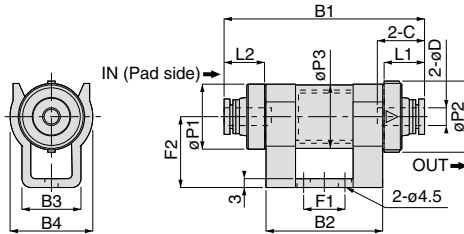
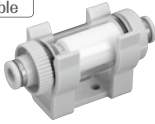

Unit : mm

Model code	Tube O.D. φD	B1	B2	B3	B4	L1	L2	φP1	φP2	φP3	C	F1	F2	Filter area (cm <sup>2</sup> )	Weight (g)	CAD file name		
VFU2-44P-□	4	58	33	18	24	11.9	11.9	18.2	20	17.5	14.9	10	20	7.5	18	VFU2-44P		
VFU2-66P-□	6	60				13	13									16	19	VFU2-66P
VFU3-66P-□	6	67.7	39.5	20	28	13.5	13.8	22.1	24	21.5	17.9	14	24	12.5	29	VFU3-66P		
VFU3-88P-□	8	70.1				14.9	14.7									19.2	29	VFU3-88P
VFU3-1010P-□	10	72.7				16.2	16									19.2	32	VFU3-1010P

※ 1. Fill in □ in Model code with "NH" for no fixing holder.

※ 2. Add "-S3" at the end of model code for "Copper alloy free".

## Replacement of Element

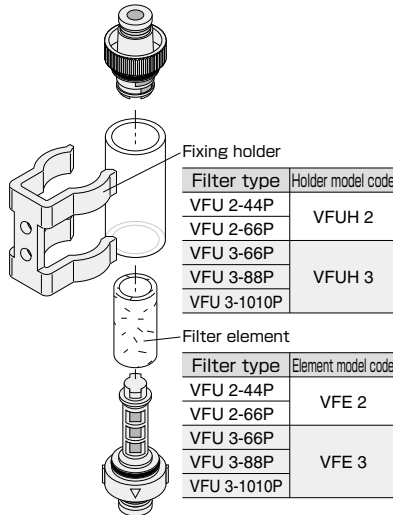

VACUUM ACCESSORIES

Vacuum Filter  
Free Holder  
Full Position Valve  
8mm LED Pressure Sensor  
LED Pressure Sensor  
Small Sensor  
Pressure Sensor With Display

## Vacuum Filter Series

VACUUM GENERATOR

EXTERNAL VACUUM CONTROLLER

VACUUM PAD

VACUUM ACCESSORIES

### Replacement & Lock Method of Filter: Union Type

#### Removing Method

- ① Turn Body B in the counterclockwise direction by 45 degrees\*.
- ② Pull out Body B.

\*. Do not rotate Body B over 45 degrees. It may cause damage to the product.

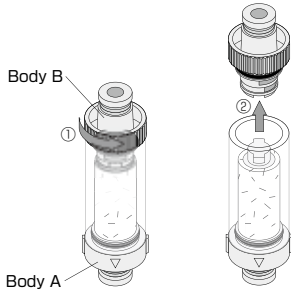

#### Lock Method

- ① Push the keyway of Body B into the projection part of Body A until Body A and B touches each other.
- ② Turn Body B in the clockwise direction by 45 degrees to lock\*1.

\*1. Do not rotate Body B over 45 degrees. It may cause damage to the product.

\*2. When Body A and B combine as the drawing below, make sure the projection part of Body A fits keyway of Body B properly.

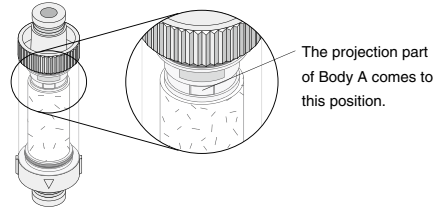
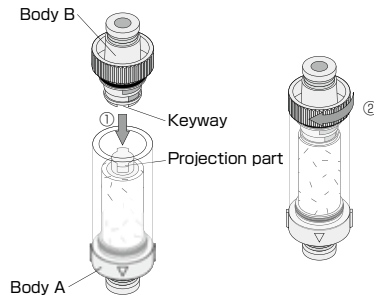



## VFF Pad Direct Mounting



RoHS compliant

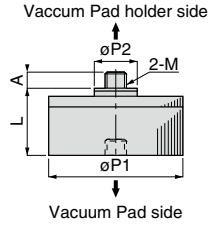

Unit : mm

Model code	M	A	L	øP1	øP2	Filter area (cm <sup>2</sup> )	Weight (g)	CAD file name
VFF15-M4	M4×0.7	3	12	25	7.8	1.7	13.5	VGF-006
VFF15-M6	M6×1	4			8.8		14	
VFF30-M6	M6×1	4	15.5	40	8.8	7	37.5	

※ Filter element model code VFF15-M□ : VFFE15  
VFF30-M6 : VFFE30

## Replacement Element

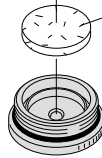
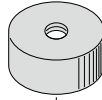

Filter element

Filter type	Element model code
VFF 15-M4	VFFE 15
VFF 15-M6	
VFF 30-M6	VFFE 30

## VFJ Plug-in Type



RoHS compliant

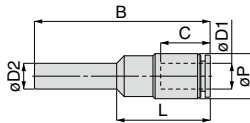

Unit : mm

Model code	Tube O.D. øD1	Fitting dia. øD2	B	L	C	øP	Filter area (cm <sup>2</sup> )	Weight (g)
VFJ33M	3	3	34.7	22	11	8	0.8	1.4
VFJ44	4	4	38.6	21.5	11	8	0.8	1.5
VFJ66	6	6	41	21.8	11.6	10.5	1.1	2.5
VFJ1/8-1/8M	1/8	1/8	34.7	22	11	8	0.8	1.4



Characteristic chart page



CAD data is available at PISCO website.

## Vacuum Filter Series

VACUUM GENERATOR

EXTERNAL VACUUM CONTROLLER

VACUUM PAD

VACUUM ACCESSORIES

### Construction (VFF15-M4)

● Pad dia. :  $\phi 10\text{mm}$ ,  $\phi 15\text{mm}$

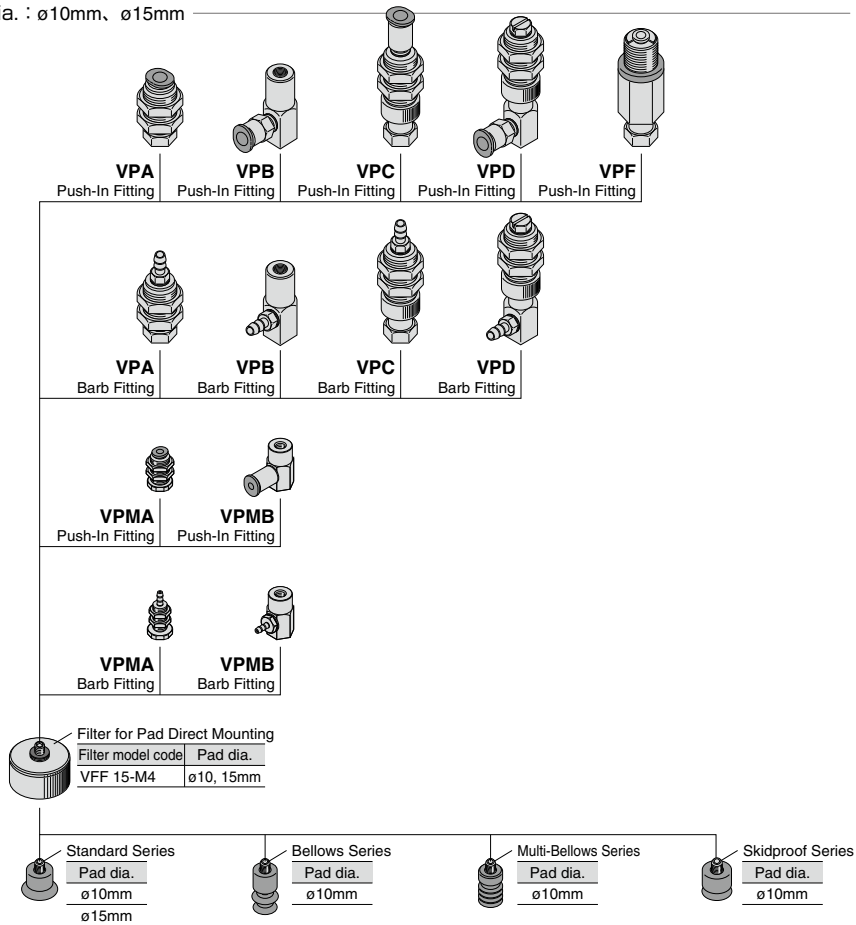

■ Construction (VFF15-M6, VFF30-M6)

● Pad dia. :  $\phi 20\text{mm}$ ,  $\phi 25\text{mm}$ ,  $\phi 30\text{mm}$ ,  $\phi 40\text{mm}$ ,  $\phi 50\text{mm}$ ,  $4 \times 10\text{mm}$ ,  $4 \times 20\text{mm}$ ,  $4 \times 30\text{mm}$ ,  $5 \times 10\text{mm}$ ,  $5 \times 20\text{mm}$ ,  $5 \times 30\text{mm}$ ,  $6 \times 10\text{mm}$ ,  $6 \times 20\text{mm}$ ,  $6 \times 30\text{mm}$ ,  $8 \times 20\text{mm}$ ,  $8 \times 30\text{mm}$

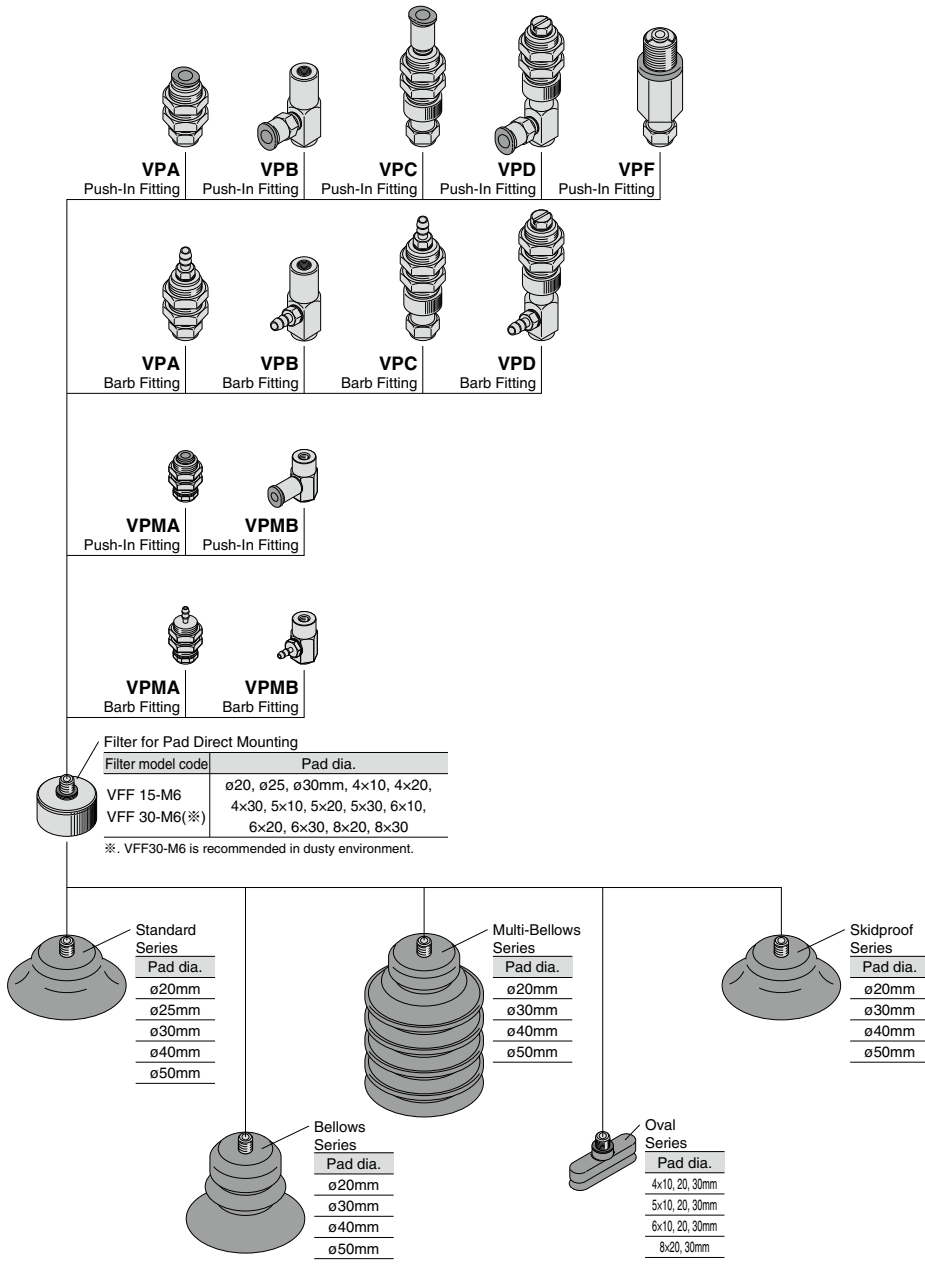



# Vacuum Accessories Series

## Vacuum Filter Series

VACUUM  
GENERATOR

EXTERNAL VACUUM  
CONTROLLER

VACUUM  
PAD

VACUUM  
ACCESSORIES

777

Small Vacuum  
Regulator

Auto on Board  
Controller

Vacuum  
Filter



# SAFETY Instructions

This safety instructions aim to prevent personal injury and damage to properties by requiring proper use of PISCO products.

Be certain to follow ISO 4414 and JIS B 8370

ISO 4414 : Pneumatic fluid power...Recommendations for the application of equipment to transmission and control systems.

JIS B 8370 : General rules and safety requirements for systems and their components.

This safety instructions is classified into "Danger", "Warning" and "Caution" depending on the degree of danger or damages caused by improper use of PISCO products.



**Danger**

Hazardous conditions. It can cause death or serious personal injury.



**Warning**

Hazardous conditions depending on usages. Improper use of PISCO products can cause death or serious personal injury.



**Caution**

Hazardous conditions depending on usages. Improper use of PISCO products can cause personal injury or damages to properties.



## Warning

### 1. Selection of pneumatic products

- ① A user who is a pneumatic system designer or has sufficient experience and technical expertise should select PISCO products.
- ② Due to wide variety of operating conditions and applications for PISCO products, carry out the analysis and evaluation on PISCO products. The pneumatic system designer is solely responsible for assuring that the user's requirements are met and that the application presents no health or safety hazards. All designers are required to fully understand the specifications of PISCO products and constitute all systems based on the latest catalog or information, considering any malfunctions.

### 2. Handle the pneumatic equipment with enough knowledge and experience

- ① Improper use of compressed air is dangerous. Assembly, operation and maintenance of machines using pneumatic equipment should be conducted by a person with enough knowledge and experience.

### 3. Do not operate machine / equipment or remove pneumatic equipment until safety is confirmed.

- ① Make sure that preventive measures against falling work-pieces or sudden movements of machine are completed before inspection or maintenance of these machine.
- ② Make sure the above preventive measures are completed. A compressed air supply and the power supply to the machine must be off, and also the compressed air in the systems must be exhausted.
- ③ Restart the machines with care after ensuring to take all preventive measures against sudden movements.

## Disclaimer

1. PISCO does not take any responsibility for any incidental or indirect loss, such as production line stop, interruption of business, loss of benefits, personal injury, etc., caused by any failure on use or application of PISCO products.
2. PISCO does not take any responsibility for any loss caused by natural disasters, fires not related to PISCO products, acts by third parties, and intentional or accidental damages of PISCO products due to incorrect usage.
3. PISCO does not take any responsibility for any loss caused by improper usage of PISCO products such as exceeding the specification limit or not following the usage the published instructions and catalog allow.
4. PISCO does not take any responsibility for any loss caused by remodeling of PISCO products, or by combinational use with non-PISCO products and other software systems.
5. The damages caused by the defect of Pisco products shall be covered but limited to the full amount of the PISCO products paid by the customer.



# SAFETY INSTRUCTION MANUAL

PISCO products are designed and manufactured for use in general industrial machines. Be sure to read and follow the instructions below.

## Danger

1. Do not use PISCO products for the following applications.
  - ① Equipment used for maintaining / handling human life and body.
  - ② Equipment used for moving / transporting human.
  - ③ Equipment specifically used for safety purposes.

## Warning

1. Do not use PISCO products under the following conditions.
  - ① Beyond the specifications or conditions stated in the catalog, or the instructions.
  - ② Under the direct sunlight or outdoors.
  - ③ Excessive vibrations and impacts.
  - ④ Exposure / adhere to corrosive gas, inflammable gas, chemicals, seawater, water and vapor. \*
    - \* Some products can be used under the condition above(④), refer to the details of specification and condition of each product.
2. Do not disassemble or modify PISCO products, which affect the performance, function, and basic structure of the product.
3. Turn off the power supply, stop the air supply to PISCO products, and make sure there is no residual air pressure in the pipes before maintenance and inspection.
4. Do not touch the release-ring of push-in fitting when there is a working pressure. The lock may be released by the physical contact, and tube may fly out or slip out.
5. Frequent switchover of compressed air may generate heat, and there is a risk of causing burn injury.
6. Avoid any load on PISCO products, such as a tensile strength, twisting and bending. Otherwise, there is a risk of causing damage to the products.
7. As for applications where threads or tubes swing / rotate, use Rotary Joints, High Rotary Joints or Multi-Circuit Rotary Block only. The other PISCO products can be damaged in these applications.
8. Use only Die Temperature Control Fitting Series, Tube Fitting Stainless SUS316 Series, Tube Fitting Stainless SUS316 Compression Fitting Series or Tube Fitting Brass Series under the condition of over 60°C (140° F) water or thermal oil. Other PISCO products can be damaged by heat and hydrolysis under the condition above.
9. As for the condition required to dissipate static electricity or provide an antistatic performance, use EG series fitting and antistatic products only, and do not use other PISCO products. There is a risk that static electricity can cause system defects or failures.
10. Use only Fittings with a characteristic of spatter-proof such as Anti-spatter or Brass series in a place where flame and weld spatter is produced. There is a risk of causing fire by sparks.
11. Turn off the power supply to PISCO products, and make sure there is no residual air pressure in the pipes and equipment before maintenance. Follow the instructions below in order to ensure safety.
  - ① Make sure the safety of all systems related to PISCO products before maintenance.
  - ② Restart of operation after maintenance shall be proceeded with care after ensuring safety of the system by preventive measures against unexpected movements of machines and devices where pneumatic equipment is used.
  - ③ Keep enough space for maintenance when designing a circuit.
12. Take safety measures such as providing a protection cover if there is a risk of causing damages or fires on machine / facilities by a fluid leakage.

### ⚠ Caution

1. Remove dusts or drain before piping. They may get into the peripheral machine / facilities and cause malfunction.
2. When inserting an ultra-soft tube into push-in fitting, make sure to place an Insert Ring into the tube edge. There is a risk of causing the escape of tube and a fluid leakage without using an Insert Ring.
3. The product incorporating NBR as seal rubber material has a risk of malfunction caused by ozone crack. Ozone exists in high concentrations in static elimination air, clean-room, and near the high-voltage motors, etc. As a countermeasure, material change from NBR to HNBR or FKM is necessary. Consult with PISCO for more information.
4. Special option "Oil-free" products may cause a very small amount of a fluid leakage. When a fluid medium is liquid or the products are required to be used in harsh environments, contact us for further information.
5. In case of using non-PISCO brand tubes, make sure the tolerance of the outer tube diameter is within the limits of Table 1.

● Table 1. Tube O.D. Tolerance

mm size	Nylon tube	Polyurethane tube	inch size	Nylon tube	Polyurethane tube
ø1.8mm	—	± 0.05mm	ø1/8	± 0.1mm	± 0.15mm
ø3mm	—	± 0.15mm	ø5/32	± 0.1mm	± 0.15mm
ø4mm	± 0.1mm	± 0.15mm	ø3/16	± 0.1mm	± 0.15mm
ø6mm	± 0.1mm	± 0.15mm	ø1/4	± 0.1mm	± 0.15mm
ø8mm	± 0.1mm	± 0.15mm	ø5/16	± 0.1mm	± 0.15mm
ø10mm	± 0.1mm	± 0.15mm	ø3/8	± 0.1mm	± 0.15mm
ø12mm	± 0.1mm	± 0.15mm	ø1/2	± 0.1mm	± 0.15mm
ø16mm	± 0.1mm	± 0.15mm	ø5/8	± 0.1mm	± 0.15mm

### 6. Instructions for Tube Insertion

- ① Make sure that the cut end surface of the tube is at right angle without a scratch on the surface and deformations.
- ② When inserting a tube, the tube needs to be inserted fully into the push-in fitting until the tubing edge touches the tube end of the fitting as shown in the figure below. Otherwise, there is a risk of leakage.

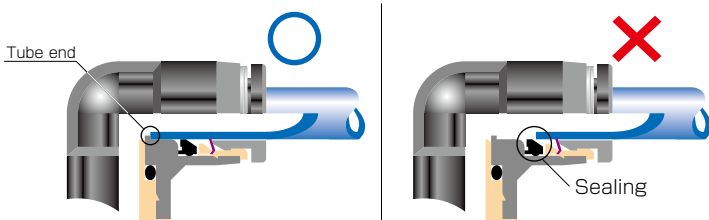

Tube is not fully inserted up to tube end.

- ③ After inserting the tube, make sure it is inserted properly and not to be disconnected by pulling it moderately.
- ※ When inserting tubes, Lock-claws may be hardly visible in the hole, observed from the front face of the release-ring. But it does not mean the tube will surely escape. Major causes of the tube escape are the followings;
- ① Shear drop of the lock-claws edge
  - ② The problem of tube diameter (usually small)
- Therefore, follow the above instructions from ① to ③, even lock-claws is hardly visible.



7. Instructions for Tube Disconnection

- ① Make sure there is no air pressure inside of the tube, before disconnecting it.
- ② Push the release-ring of the push-in fitting evenly and deeply enough to pull out the tube toward oneself. By insufficient pushing of the release-ring, the tube may not be pulled out or damaged by scratch, and tube shavings may remain inside of the fitting, which may cause the leakage later.

8. Instructions for Installing a fitting

- ① When installing a fitting, use proper tools to tighten a hexagonal-column or an inner hexagonal socket. When inserting a hex key into the inner hexagonal socket of the fitting, be careful so that the tool does not touch lock-claws. The deformation of lock-claws may result in a poor performance of systems or an escape of the tube.
- ② Refer to Table 2 which shows the recommended tightening torque. Do not exceed these limits to tighten a thread. Excessive tightening may break the thread part or deform the gasket and cause a fluid leakage. Tightening thread with tightening torque lower than these limits may cause a loosened thread or a fluid leakage.
- ③ Adjust the tube direction while tightening thread within these limits, since some PISCO products are not rotatable after the installation.

● Table 2: Recommended tightening torque / Sealock color / Gasket materials

Thread type	Thread size	Tightening torque	Sealock color	Gasket materials
Metric thread	M3 × 0.5	0.7N·m	—	SUS304 NBR
	M5 × 0.8	1.0 ~ 1.5N·m		
	M6 × 1	2 ~ 2.7N·m		
	M3 × 0.5	0.5 ~ 0.6N·m		POM
	M5 × 0.8	1 ~ 1.5N·m		
	M6 × 0.75	0.8 ~ 1N·m		
Taper pipe thread	M8 × 0.75	1 ~ 2N·m	White	—
	R1/8	7 ~ 9N·m		
	R1/4	12 ~ 14N·m		
	R3/8	22 ~ 24N·m		
Unified thread	R1/2	28 ~ 30N·m	—	SUS304, NBR
	No.10-32UNF	1.0 ~ 1.5N·m		
National pipe thread taper	1/16-27NPT	7 ~ 9N·m	White	—
	1/8-27NPT	7 ~ 9N·m		
	1/4-18NPT	12 ~ 14N·m		
	3/8-18NPT	22 ~ 24N·m		
	1/2-14NPT	28 ~ 30N·m		

※ These values may differ for some products. Refer to each specification as well.

9. Instructions for removing a fitting

- ① When removing a fitting, use proper tools to loosen a hexagonal-column or an inner hex bolt.
- ② Remove the sealant stuck on the mating equipment. The remained sealant may get into the peripheral equipment and cause malfunctions.

10. Arrange piping avoiding any load on fittings and tubes such as twist, tensile, moment load, shaking and physical impact. These may cause damages to fittings, tube deformations, bursting and the escape of tubes.



### Common Safety Instructions for Vacuum Series

Before selecting or using PISCO products, read the following instructions. Read the detailed instructions for individual series.

#### Warning

1. If there is a risk of dropping work-pieces during vacuum suction, take a safety measure against the falling of them.
2. Avoid supplying more than 0.1MPa pressure constantly in a vacuum circuit. Since vacuum generators are not explosive-proof, there is a risk of damaging the products.
3. Pay attention to drop of vacuum pressure caused by problems of the supplied air or the power supply. Decrease of suction force may lead to a danger of falling work-piece so that safety measure against the falling of them is necessary.
4. When more than 2 vacuum pads are plumbed on a single ejector and one of them has a suction problem such as vacuum leak, there is a risk of releasing work-pieces from the other pad due to the drop of the vacuum pressure.
5. Do not use in the way by which exhaust port is blocked or exhaust resistance is increased. Otherwise, there is a risk of no vacuum generation or a drop of the vacuum pressure.
6. Do not use the product in the circumstance of corrosive gas, inflammable gas, explosive gas, chemicals, seawater and vapor or do not expose the product to those. Never allow the product to suck those things.
7. Provide a protective cover on the products when it is exposed to sunlight.
8. Carry out clogging check for silencer element in an ejector and a vacuum filter periodically. Clogged element will be a cause to impair the performance or a cause of troubles.
9. Before replacing the element, thoroughly read and understand the method of filter replacement in the catalog.
10. Make sure the correct port of the vacuum generator by this catalog or marking on the products when plumbing. Wrong plumbing can be a risk to damage the product.
11. Supply clean air without sludge or dusts to an ejector. Do not lubricate by a lubricator. There is a risk of malfunction or performance impairing by impurities and oil contained in the compressed air.
12. Do not apply extreme tension, twist or bending forces on a lead wire. Otherwise, it may cause a wire breaking.
13. Locknut needs to be tightened firmly by hand. Do not use any tool to tighten. In case of using tools to tighten the locknut, it may damage the locknut or the product. Inadequate tightening may loosen the locknut and the initial setting can be changed.
14. Do not force the product to rotate or swing even its resin body is rotatable. It may cause damage to the product and a fluid leakage.
15. Do not supply an air pressure or a dry air to the products over the necessary amount. There is a risk of deteriorating rubber materials and malfunction due to oil.
16. Keep the product away from water, oil drops or dusts. These may cause malfunction. Take a proper measure to protect the product before the operation.

17. Do not use the product in the environment of inflammable or explosive gas / fluid. It can cause a fire or an explosion hazard.
18. Do not use the product in the circumstance of corrosive gas, inflammable gas, explosive gas, chemicals, seawater and vapor or do not expose the product to those. Otherwise, it may be a cause of malfunction.
19. Do not clean or paint the products by water or a solvent.

### ⚠ Caution

1. Operating pressure range in the catalog is the values during ejector operation. Secure the described value of the supplied air, taking a drop of the pressure into consideration. Insufficient pressure, which does not satisfy the spec, may cause abnormal noise, unstable performance and may negatively affect sensors, bringing troubles at last.
2. Effective cross-section area of the air supply side needs to be three times as large as effective cross-section area of the nozzle bore. When arranging piping or selecting PISCO products, secure required effective cross-section area. Insufficient supply pressure may be a cause to impair performance.
3. A Shorter distance of plumbing with a wider bore is preferable at vacuum system side. A long plumbing with a small bore may result in slow response time at the time of releasing work-piece as well as in failure to secure adequate suction flow rate.
4. Plumb a vacuum switch and an ejector with vacuum switch at the end of vacuum system as much as possible. A long distance between a vacuum switch and a vacuum system end may increase plumbing resistance which may lead to a high vacuum level at the sensor even when no suctioning and a malfunction of vacuum switch. Make sure to evaluate the products in an actual system.
5. Refer to "4. Instructions for Installing a fitting" and "5. Instructions for Removing a fitting" under "Common Safety Instructions for Fittings" , when installing or removing Fittings.
6. Refer to "Common Safety Instructions for Pressure Sensors" and "Detailed Safety Instructions" for the handling of digital vacuum switch sensor.
7. Refer to "Common Safety Instructions for Mechanical Vacuum Sensor" for the handling of mechanical vacuum switch.
8. The material of plastic filter cover for VG, VK, VJ, VZ and VX series is PCTG. Avoid the adherence of Chemicals below to the products, and do not use them under those chemical environments.

#### ● Table Chemical Name

Chemical Name
Thinner
Carbon tetrachloride
Chloroform
Acetate
Aniline
Cyclohexane
Trichloroethylene
Sulfuric acid
Lactic acid
Water soluble cutting oil (alkaline)

\* There are more chemicals which should be avoided. Contact us for the use under chemical circumstance.

VACUUM GENERATOR  
EXTERNAL VACUUM CONTROLLER  
VACUUM PAD  
VACUUM ACCESSORIES  
48  
VH-VS  
VU  
VUM  
VY  
VB  
VM-VC  
VRL  
VG  
VK  
VJ  
VX  
VQ  
VZ  
VN

9. The material of plastic filter cover for VQ and VFU series is PA. Avoid the adherence of chemicals below to the products, and do not use them under those chemical environments.

● Table Chemical Name

Chemical Name
Methanol
Ethanol
Nitric acid
Sulfuric acid
Hydrochloric acid
Lactic acid
Acetone
Chloroform
Aniline
Trichloroethylene
Hydrogen peroxide

\* There are more chemicals which should be avoided. Contact us for the use under chemical circumstance.