

Renewal



Push-In Fitting Type Speed Controller of Stainless Steel Speed Controller **SUS303** Equivalent Corrosivity

Copper alloy
free material

● *Stainless steel (Cr 19~21%, Mo 1.5~2.5%) whose Corrosion resistance is equivalent to SUS303 is adopted.*

● *Copper alloy free Material*

● *HNBR for Seal Rubber against Low Ozone Concentration*

Model Designation (Example)

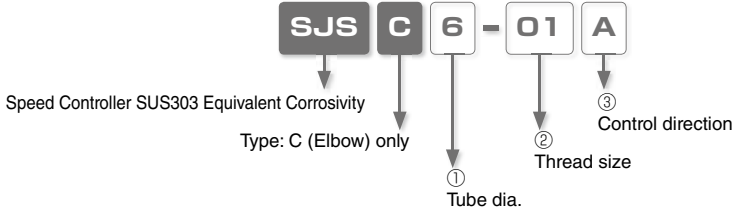

① Tube dia.

Tube dia.	mm size				
Code	4	6	8	10	12
Size	ø4	ø6	ø8	ø10	ø12

② Thread size

Thread size	Metric thread type(mm)	Taper pipe thread			
Code	M5	01	02	03	04
Size	M5 × 0.8	R1/8	R1/4	R3/8	R1/2

③ Control direction

Code	A	B
Control direction	<p>Meter-out</p> <p>■ Air from thread side is controlled. Air from tube side is not controlled and flows out from thread side.</p>	<p>Meter-in</p> <p>■ Air from tube side is controlled. Air from thread side is not controlled and flows out from tube side.</p>
Identification	"A" is marked on the top of needle. Locknut color: Silver	"B" is marked on the top of needle. Locknut color: Black

Specifications

Fluid medium	Air
Operating pressure range	0.1 ~ 0.9MPa
Check valve cracking pressure	0.05MPa
Operating temp. range	0~60℃ (No freezing)

Construction



Symbol

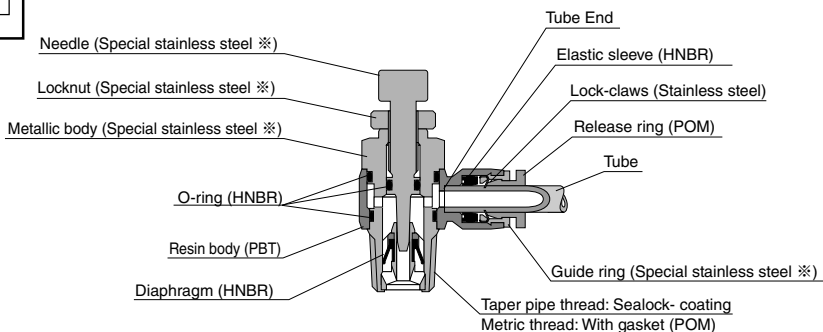

※ Equivalent Corrosion Resistance to SUS303

△ Detailed Safety Instructions

Before using PISCO products, be sure to read "Safety Instructions" and "Safety Instruction Manual" on page 23 to 27 and "Common Safety Instructions for Controllers" on page 367 to 368.

Warning

1. When controlling the speed of actuators, slowly release the air by adjusting the needle from a fully closed state. In case the needle is opened, actuator can move suddenly. Turn needle in the clockwise direction to close, and in the counterclockwise to open.
2. Do not swing or rotate resin body of the products by force. It may damage to the products and cause a fluid leakage.
3. Chemical resistant level is equivalent to SUS430. In case that higher level of the resistance is required, do not use the products.
4. Contact us when the products are used under the corrosive environment. There is a possibility to cause damage to the products, depending on the conditions.

Caution

1. Speed controller permits some air leakage. Do not use the products for the application which requires no leakage.

How to identify the series of Speed Controller

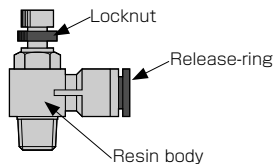

Type	Release-ring shape/color	Resin body color	Locknut color		Marking on needle	
			A type	B type	A type	B type
Standard	Oval, Round / Black	Black	Silver	Black	A (AK)	B (BK)
Clean-room package	Oval, Round / Light-blue	Light-gray				
High-flow Series	Round / Black	Black	Blue	—	AG	—
Low-flow Series	Oval, Round / Black	Black	Silver	Black	AT	BT
SUS303 Series	Oval, Round / Dark-blue	Black	Silver	Black	A	B
PP Series	Round / Semitransparent	Semitransparent	Silver	Silver	A (AK)	B (BK)

※ 1. () is for low cracking pressure type.

How to adjust the speed

1. Speed adjustment of actuators

① Increasing speed

Turn the needle in the counterclockwise direction from a fully closed state. The more the needle is opened, the faster the actuator moves. Make sure to tighten the locknut at the desired speed. The speed setting can be changed without tightening the locknut.

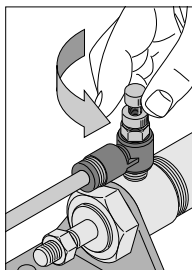

② Reducing speed

Turn the needle in the clockwise direction when the speed is too fast. Make sure to tighten the locknut at the desired speed. The speed setting can be changed without tightening the locknut.

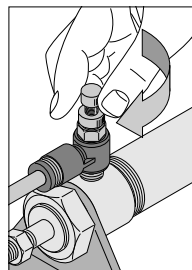

How to insert and disconnect

1. How to insert and disconnect tubes

① Tube insertion

Insert a tube into Push-In Fitting up to the tube end. Lock-claws bite the tube and fix it automatically, then the elastic sleeve seals around the tube.

Refer to "2. Instructions for Tube Insertion" under "Common Safety Instructions for Fittings" .

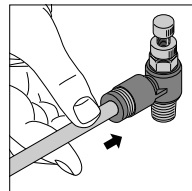

② Tube disconnection

The tube is disconnected by pushing release-ring to release Lock-claws.

Make sure to stop air supply before the tube disconnection.

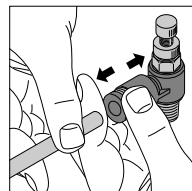

2. How to tighten thread

① Tightening thread

Use a spanner to tighten a hexagonal-column.

Refer to "Table: Recommended tightening torque" under "2. Instructions for Installing Controllers" in "Common Safety Instructions for Controllers" .

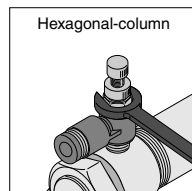

Applicable Tube and Related Products

Polyurethane Tube...P.596

Nylon Tube...P.608

Fluororesin (PFA) Tube...P.628

SJSC Elbow

RoHS compliant

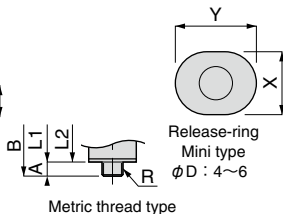
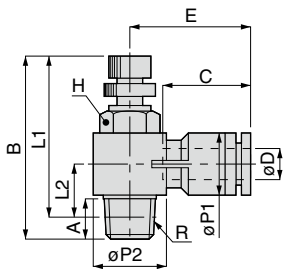

Unit : mm

Model code	Tube O.D. øD	R	A	B		L1		L2	øP1	øP2	Tube end C	E	Hex. H	X (øX)	Y	Weight (g)	CAD file name	
				max.	min.	max.	min.											
SJSC4-M5	4	M5×0.8	3.2	29.7	27	26.5	23.8	6.4	8	9.8	11	15.4	8	7.8	9.8	7	SJSC4-M5_	
SJSC4-01		R1/8	8	40.7	34.4	36.7	30.4	10.7				14.4	17.7			10	17	SJSC4-01_
SJSC6-M5	6	M5×0.8	3.2	29.7	27	26.5	23.8	7.2	10.5	14.4	11.6	18.3	10	9.8	11.8	17	SJSC6-M5_	
SJSC6-01		R1/8	8	40.7	34.4	36.7	30.4	10.7				18.4	20.2			14	33	SJSC6-01_
SJSC6-02		R1/4	11.1	47.8	41.4	41.8	35.4	11.9				18.4	20.2			14	33	SJSC6-02_
SJSC6-03		R3/8	13.2	53.7	46.5	47.3	40.1	15.4				14.4	22			17	29	19
SJSC8-01	8	R1/8	8	40.7	34.4	36.7	30.4	11.9	14.4	14.4	18.1	26.9	10	13.8	-	20	SJSC8-01_	
SJSC8-02		R1/4	11.1	47.8	41.4	41.8	35.4	13.2				18.4	28.4			14	36	SJSC8-02_
SJSC8-03		R3/8	13.2	53.7	46.5	47.3	40.1	15.4				22	28.9			19	63	SJSC8-03_
SJSC8-04		R1/2	16	59.3	52.3	51.1	44.1	18				28	31			24	95	SJSC8-04_
SJSC10-02	10	R1/4	11.1	47.8	41.4	41.8	35.4	14.8	17.6	22	20.2	30.9	14	16.8	-	39	SJSC10-02_	
SJSC10-03		R3/8	13.2	53.7	46.5	47.3	40.1	16.7				22	31.2			19	66	SJSC10-03_
SJSC10-04		R1/2	16	59.3	52.3	51.1	44.1	18				28	33.6			24	98	SJSC10-04_
SJSC12-03	12	R3/8	13.2	53.7	46.5	47.3	40.1	18.4	21	22	23.4	36.9	19	19.8	-	69	SJSC12-03_	
SJSC12-04		R1/2	16	59.3	52.3	51.1	44.1	19.7				28	36.4			24	101	SJSC12-04_

※. "L1" and "L2" are reference values for height dimensions after tightening taper thread.

※. □ in Model code / Replaced with " A " for Meter-out, " B " for Meter-in

Flow characteristic

Elbow

SJSC 4-M5
6-M5



Cylinder tube I.D.
Max. \varnothing **20**mm

Control flow

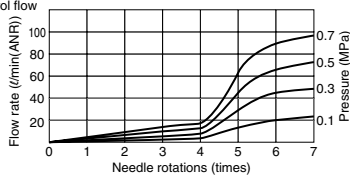

Free flow

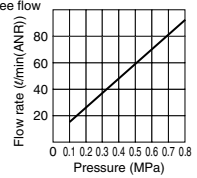

SJSC 4-01
6-01
8-01

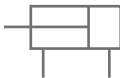

Cylinder tube I.D.
Max. \varnothing **32**mm

Control flow

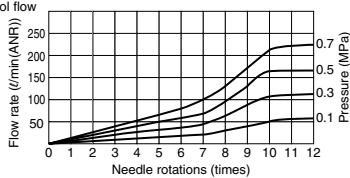

Free flow

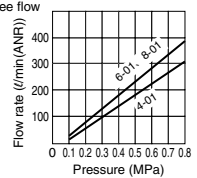

SJSC 6-02

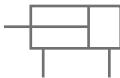

Cylinder tube I.D.
Max. \varnothing **40**mm

Control flow

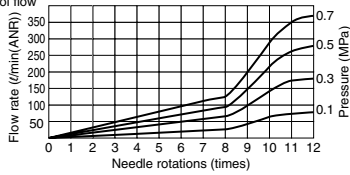

Free flow

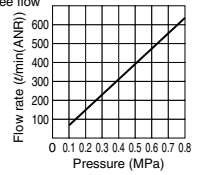

SJSC 8-02
10-02

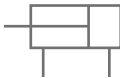

Cylinder tube I.D.
Max. \varnothing **40**mm

Control flow

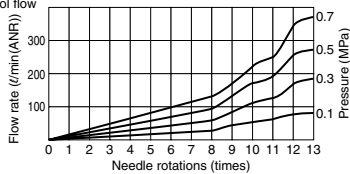

Free flow

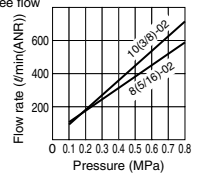

SJSC 6-03

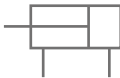

Cylinder tube I.D.
Max. \varnothing **63**mm

Control flow

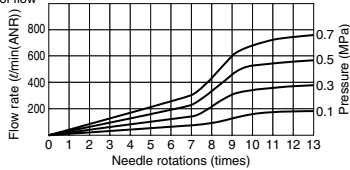

Free flow

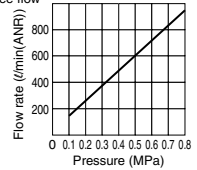

SJSC 8-03

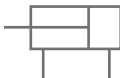

Cylinder tube I.D.
Max. \varnothing **63**mm

Control flow

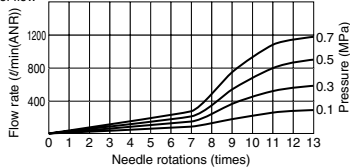

Free flow

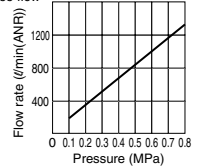

CONTROLLER VALVE

TUBE

MADE-TO-ORDER PRODUCTS

410

Stainless Series

PP Series

Anti-scatter Series

Constant Flow Series

Throttle Needle Valve Series

Stainless Series

PP Series

Anti-scatter Series

Quick Exhaust Valve Series

Exhaust Valve Series

Fused orifice Series

Pressure Control Series

Pressure Relief Series

Check Valve Series

Silencer Series

SJSC 10-03

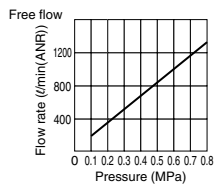
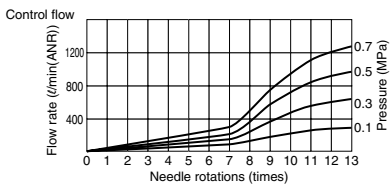
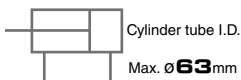

SJSC 12-03

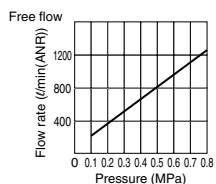
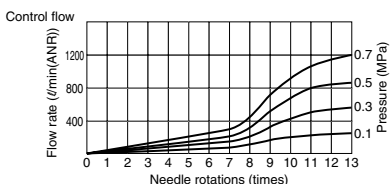
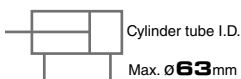

SJSC 8-04

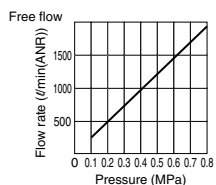
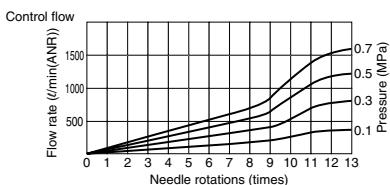
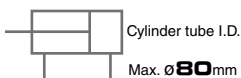

SJSC 10-04

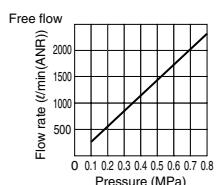
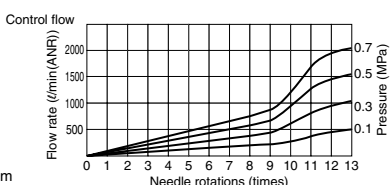
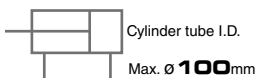

SJSC 12-04

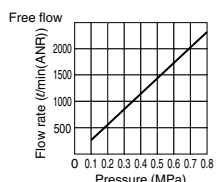
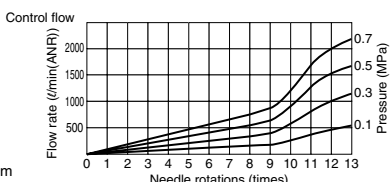
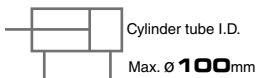



SAFETY Instructions

This safety instructions aim to prevent personal injury and damage to properties by requiring proper use of PISCO products.

Be certain to follow ISO 4414 and JIS B 8370

ISO 4414 : Pneumatic fluid power...Recommendations for the application of equipment to transmission and control systems.

JIS B 8370 : General rules and safety requirements for systems and their components.

This safety instructions is classified into "Danger", "Warning" and "Caution" depending on the degree of danger or damages caused by improper use of PISCO products.



Danger

Hazardous conditions. It can cause death or serious personal injury.



Warning

Hazardous conditions depending on usages. Improper use of PISCO products can cause death or serious personal injury.



Caution

Hazardous conditions depending on usages. Improper use of PISCO products can cause personal injury or damages to properties.



Warning

1. Selection of pneumatic products

- ① A user who is a pneumatic system designer or has sufficient experience and technical expertise should select PISCO products.
- ② Due to wide variety of operating conditions and applications for PISCO products, carry out the analysis and evaluation on PISCO products. The pneumatic system designer is solely responsible for assuring that the user's requirements are met and that the application presents no health or safety hazards. All designers are required to fully understand the specifications of PISCO products and constitute all systems based on the latest catalog or information, considering any malfunctions.

2. Handle the pneumatic equipment with enough knowledge and experience

- ① Improper use of compressed air is dangerous. Assembly, operation and maintenance of machines using pneumatic equipment should be conducted by a person with enough knowledge and experience.

3. Do not operate machine / equipment or remove pneumatic equipment until safety is confirmed.

- ① Make sure that preventive measures against falling work-pieces or sudden movements of machine are completed before inspection or maintenance of these machine.
- ② Make sure the above preventive measures are completed. A compressed air supply and the power supply to the machine must be off, and also the compressed air in the systems must be exhausted.
- ③ Restart the machines with care after ensuring to take all preventive measures against sudden movements.

Disclaimer

1. PISCO does not take any responsibility for any incidental or indirect loss, such as production line stop, interruption of business, loss of benefits, personal injury, etc., caused by any failure on use or application of PISCO products.
2. PISCO does not take any responsibility for any loss caused by natural disasters, fires not related to PISCO products, acts by third parties, and intentional or accidental damages of PISCO products due to incorrect usage.
3. PISCO does not take any responsibility for any loss caused by improper usage of PISCO products such as exceeding the specification limit or not following the usage the published instructions and catalog allow.
4. PISCO does not take any responsibility for any loss caused by remodeling of PISCO products, or by combinational use with non-PISCO products and other software systems.
5. The damages caused by the defect of Pisco products shall be covered but limited to the full amount of the PISCO products paid by the customer.



SAFETY INSTRUCTION MANUAL

PISCO products are designed and manufactured for use in general industrial machines. Be sure to read and follow the instructions below.

Danger

1. Do not use PISCO products for the following applications.
 - ① Equipment used for maintaining / handling human life and body.
 - ② Equipment used for moving / transporting human.
 - ③ Equipment specifically used for safety purposes.

Warning

1. Do not use PISCO products under the following conditions.
 - ① Beyond the specifications or conditions stated in the catalog, or the instructions.
 - ② Under the direct sunlight or outdoors.
 - ③ Excessive vibrations and impacts.
 - ④ Exposure / adhere to corrosive gas, inflammable gas, chemicals, seawater, water and vapor. *
* Some products can be used under the condition above(④), refer to the details of specification and condition of each product.
2. Do not disassemble or modify PISCO products, which affect the performance, function, and basic structure of the product.
3. Turn off the power supply, stop the air supply to PISCO products, and make sure there is no residual air pressure in the pipes before maintenance and inspection.
4. Do not touch the release-ring of push-in fitting when there is a working pressure. The lock may be released by the physical contact, and tube may fly out or slip out.
5. Frequent switchover of compressed air may generate heat, and there is a risk of causing burn injury.
6. Avoid any load on PISCO products, such as a tensile strength, twisting and bending. Otherwise, there is a risk of causing damage to the products.
7. As for applications where threads or tubes swing / rotate, use Rotary Joints, High Rotary Joints or Multi-Circuit Rotary Block only. The other PISCO products can be damaged in these applications.
8. Use only Die Temperature Control Fitting Series, Tube Fitting Stainless SUS316 Series, Tube Fitting Stainless SUS316 Compression Fitting Series or Tube Fitting Brass Series under the condition of over 60°C (140° F) water or thermal oil. Other PISCO products can be damaged by heat and hydrolysis under the condition above.
9. As for the condition required to dissipate static electricity or provide an antistatic performance, use EG series fitting and antistatic products only, and do not use other PISCO products. There is a risk that static electricity can cause system defects or failures.
10. Use only Fittings with a characteristic of spatter-proof such as Anti-spatter or Brass series in a place where flame and weld spatter is produced. There is a risk of causing fire by sparks.
11. Turn off the power supply to PISCO products, and make sure there is no residual air pressure in the pipes and equipment before maintenance. Follow the instructions below in order to ensure safety.
 - ① Make sure the safety of all systems related to PISCO products before maintenance.
 - ② Restart of operation after maintenance shall be proceeded with care after ensuring safety of the system by preventive measures against unexpected movements of machines and devices where pneumatic equipment is used.
 - ③ Keep enough space for maintenance when designing a circuit.
12. Take safety measures such as providing a protection cover if there is a risk of causing damages or fires on machine / facilities by a fluid leakage.

⚠ Caution

1. Remove dusts or drain before piping. They may get into the peripheral machine / facilities and cause malfunction.
2. When inserting an ultra-soft tube into push-in fitting, make sure to place an Insert Ring into the tube edge. There is a risk of causing the escape of tube and a fluid leakage without using an Insert Ring.
3. The product incorporating NBR as seal rubber material has a risk of malfunction caused by ozone crack. Ozone exists in high concentrations in static elimination air, clean-room, and near the high-voltage motors, etc. As a countermeasure, material change from NBR to HNBR or FKM is necessary. Consult with PISCO for more information.
4. Special option "Oil-free" products may cause a very small amount of a fluid leakage. When a fluid medium is liquid or the products are required to be used in harsh environments, contact us for further information.
5. In case of using non-PISCO brand tubes, make sure the tolerance of the outer tube diameter is within the limits of Table 1.

● Table 1. Tube O.D. Tolerance

mm size	Nylon tube	Polyurethane tube	inch size	Nylon tube	Polyurethane tube
ø1.8mm	—	± 0.05mm	ø1/8	± 0.1mm	± 0.15mm
ø3mm	—	± 0.15mm	ø5/32	± 0.1mm	± 0.15mm
ø4mm	± 0.1mm	± 0.15mm	ø3/16	± 0.1mm	± 0.15mm
ø6mm	± 0.1mm	± 0.15mm	ø1/4	± 0.1mm	± 0.15mm
ø8mm	± 0.1mm	± 0.15mm	ø5/16	± 0.1mm	± 0.15mm
ø10mm	± 0.1mm	± 0.15mm	ø3/8	± 0.1mm	± 0.15mm
ø12mm	± 0.1mm	± 0.15mm	ø1/2	± 0.1mm	± 0.15mm
ø16mm	± 0.1mm	± 0.15mm	ø5/8	± 0.1mm	± 0.15mm

6. Instructions for Tube Insertion

- ① Make sure that the cut end surface of the tube is at right angle without a scratch on the surface and deformations.
- ② When inserting a tube, the tube needs to be inserted fully into the push-in fitting until the tubing edge touches the tube end of the fitting as shown in the figure below. Otherwise, there is a risk of leakage.

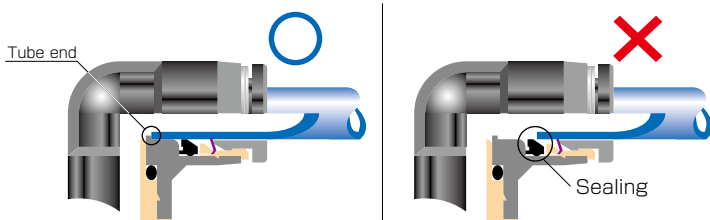

Tube is not fully inserted up to tube end.

- ③ After inserting the tube, make sure it is inserted properly and not to be disconnected by pulling it moderately.
- ※ When inserting tubes, Lock-claws may be hardly visible in the hole, observed from the front face of the release-ring. But it does not mean the tube will surely escape. Major causes of the tube escape are the followings;
- ① Shear drop of the lock-claws edge
 - ② The problem of tube diameter (usually small)
- Therefore, follow the above instructions from ① to ③, even lock-claws is hardly visible.

7. Instructions for Tube Disconnection

- ① Make sure there is no air pressure inside of the tube, before disconnecting it.
- ② Push the release-ring of the push-in fitting evenly and deeply enough to pull out the tube toward oneself. By insufficient pushing of the release-ring, the tube may not be pulled out or damaged by scratch, and tube shavings may remain inside of the fitting, which may cause the leakage later.

8. Instructions for Installing a fitting

- ① When installing a fitting, use proper tools to tighten a hexagonal-column or an inner hexagonal socket. When inserting a hex key into the inner hexagonal socket of the fitting, be careful so that the tool does not touch lock-claws. The deformation of lock-claws may result in a poor performance of systems or an escape of the tube.
- ② Refer to Table 2 which shows the recommended tightening torque. Do not exceed these limits to tighten a thread. Excessive tightening may break the thread part or deform the gasket and cause a fluid leakage. Tightening thread with tightening torque lower than these limits may cause a loosened thread or a fluid leakage.
- ③ Adjust the tube direction while tightening thread within these limits, since some PISCO products are not rotatable after the installation.

● Table 2: Recommended tightening torque / Sealock color / Gasket materials

Thread type	Thread size	Tightening torque	Sealock color	Gasket materials
Metric thread	M3 × 0.5	0.7N·m	—	SUS304 NBR
	M5 × 0.8	1.0 ~ 1.5N·m		
	M6 × 1	2 ~ 2.7N·m		
	M3 × 0.5	0.5 ~ 0.6N·m		POM
	M5 × 0.8	1 ~ 1.5N·m		
	M6 × 0.75	0.8 ~ 1N·m		
Taper pipe thread	M8 × 0.75	1 ~ 2N·m	White	—
	R1/8	7 ~ 9N·m		
	R1/4	12 ~ 14N·m		
	R3/8	22 ~ 24N·m		
Unified thread	R1/2	28 ~ 30N·m	—	SUS304, NBR
	No.10-32UNF	1.0 ~ 1.5N·m		
National pipe thread taper	1/16-27NPT	7 ~ 9N·m	White	—
	1/8-27NPT	7 ~ 9N·m		
	1/4-18NPT	12 ~ 14N·m		
	3/8-18NPT	22 ~ 24N·m		
	1/2-14NPT	28 ~ 30N·m		

※ These values may differ for some products. Refer to each specification as well.

9. Instructions for removing a fitting

- ① When removing a fitting, use proper tools to loosen a hexagonal-column or an inner hex bolt.
- ② Remove the sealant stuck on the mating equipment. The remained sealant may get into the peripheral equipment and cause malfunctions.

10. Arrange piping avoiding any load on fittings and tubes such as twist, tensile, moment load, shaking and physical impact. These may cause damages to fittings, tube deformations, bursting and the escape of tubes.

Common Safety Instructions for Controllers

Before selecting or using PISCO products, read the following instructions. Read the detailed instructions for individual series as well as the instructions below.

Warning

1. Some products have an air direction to control. Make sure to distinguish the direction by marking on the products. Installing the product with the wrong direction may cause personal injury or property damage.
2. Avoid any load on PISCO products such as a tensile strength, twisting, bending, dropping and excessive impacts. These may cause damage to the products.
3. Locknut needs to be tightened by hand. Do not use any tool. Using tools to tighten the locknut may cause damage to the products. Also, inadequate tightening may loosen the locknut and the initial setting can be changed.
4. Use clean air to supply. Dusts and sludge may result in the change of the initial setting.

⚠ Caution

1. Refer to “Common Safety Instructions for Fittings” for the safety instructions for fitting part.
2. Instructions for Installing Controllers
 - ① Use proper tools to tighten a hexagonal-column or a knurling, when installing the controller.
 - ② Refer to the following table which shows the recommended tightening torque to tighten thread. Excessive tightening may break the thread part or deform the gasket to cause a fluid leakage. Tightening thread with the tightening torque lower than these limits may cause a loosened thread or a fluid leakage.

● Table: Recommended tightening torque (hexagonal-column)

Thread type	Thread size	Tightening torque
Metric thread	M3 × 0.5	0.7Nm
	M5 × 0.8	1 ~ 1.5Nm
	M6 × 1	2 ~ 2.7Nm
Taper pipe thread	R1/8	7 ~ 9Nm
	R1/4	12 ~ 14Nm
	R3/8	22 ~ 24Nm
	R1/2	28 ~ 30Nm
Unified thread	No.10-32UNF	1.5 ~ 1.9Nm
National pipe thread taper	1/16-28NPT	7 ~ 9Nm
	1/8-27NPT	7 ~ 9Nm
	1/4-18NPT	12 ~ 14Nm
	3/8-18NPT	22 ~ 24Nm
	1/2-14NPT	28 ~ 30Nm
Parallel pipe thread	G3/8	After hand tightening 1/2~1 turns
	G1/2	

(knurling)

Thread type	Thread size	Tightening torque
Metric thread	M5 × 0.8	1/6 turns after hand tightening
	M6 × 1	
	M10 × 1	
Parallel pipe thread	G3/8	1/2~1 turns after hand tightening
	G1/2	

3. Instructions for removing Controller

- ① When removing controllers, use proper tools to loosen a hexagonal-column or a knurling.
- ② Remove the sealant stuck on the mating equipment. The remained sealant may get into the peripheral equipment and cause malfunctions.

4. Fixed Orifice Joint Series and Speed Controller Constant Flow Series have deviation of flow rate. Contact us, in case a very accurate amount of flow rate is required.

5. If PISCO products generate heat by an adiabatic compression, total temperature including the heat from the product must be controlled within the range of the specification.

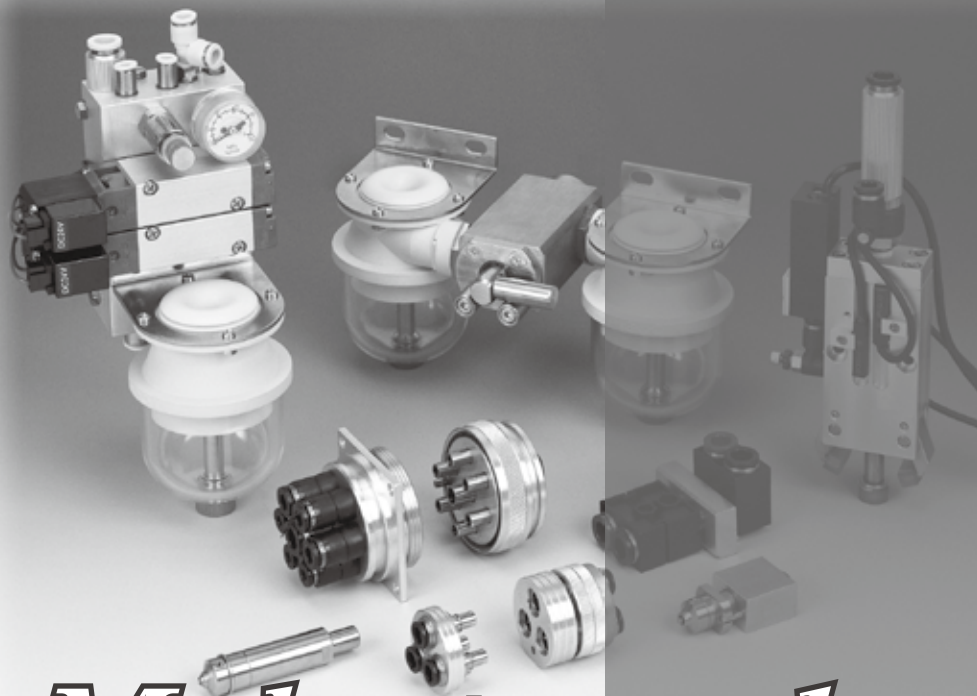

Make-to-order products

PISCO offers make-to-order products to support customer's various requirements such as special specifications, and special appearances.

Special Options

■ Characteristics

● *Color option*

Light-gray color option for resin body and release-ring.

● *Seal rubber material option*

Seal Rubber Selection: FKM or EPDM.

● *Oil-free option*

Suitable for Oil-free Environment.

● *Release-ring color option*

Changeable to Red Color

● *Non-purple option*

Suppress CU ion and F ion.

※ Note: With this option, Check Valve and Stop Fitting, etc. do not have marking on the brass parts. Be careful when piping.

Model Designation (Example)

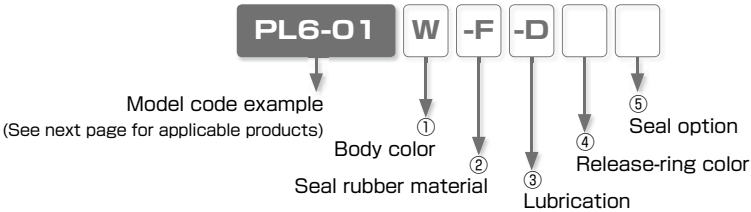

① Body color

Code	W	No code
Body color	Light-gray	Standard color

※ . W: Release-ring color is light-gray

② Seal rubber material

Code	-F	-E	No code
Material	FKM	EPDM (Oil-free)	Standard seal rubber

※ 1. FKM: Release-ring color is brown. Non-purple option is not available with FKM option.

※ 2. EPDM: All oil-free. Release-ring color is yellow.

※ 3. EPDM: Not available for Thread size M3, M6 and Fittings with Inch sized Tube dia.

③ Lubrication

Code	-D	No code
Option	Oil-free	Standard lubrication

※ 1. Oil-free : Release-ring color is yellow.

※ 2. The products with oil-free option are assembled without intentional use of lubrication through its production process. It may cause problems such as degradation of airtightness and increase of friction.

④ Release-ring color

Code	-R	No code
Color	Red	Standard color

⑤ Seal option (Taper pipe thread only)

Code	-P	No code
Option	Non-purple	Standard

※ 1. Non-purple option is not available with seal rubber FKM

※ . See next page for "Reference Chart of Special Option" .

※ . Contact the nearest sales office for the price.

Reference Chart of Special Option

○ : Available, × : Not available

Series	Standard specification						Special specification					
	Body Color and Packaging Option	Body color	Release-ring color	Seal rubber material	Lubrication	Seal option	①	②	③	④	⑤	
							Body color	Seal rubber material	Lubrication	Release-ring color	Seal option	
							W* ¹	-F* ²	-E* ³	-D* ⁴	-R	-P* ²
Light-gray	FKM	EPDM	Oil-free	Red	Non-purple							
Tube Fitting Standard Series	—	Black	Black	NBR	Turbin oil	With seal coat	—	○* ⁵	○	○	○	○
	Light-gray	Light-gray	Light-gray				Std. option	○	○	○	×	○
	Clean-room pkg	Light-gray	Light-blue		Fluorochemical grease	—	○	○* ⁶	○* ⁶	×	×	
	Light-gray + Clean-room pkg	Light-gray	Light-gray		Std. option	○	○	○	×	×		
Tube Fitting Mini Series	—	Black	Black	NBR	Turbin oil	With seal coat	—	○* ⁵	○	○	○	○
	Light-gray	Light-gray	Light-gray				Std. option	○	○	○	×	○
	Clean-room pkg	Light-gray	Light-blue		Fluorochemical grease	—	○	○* ⁶	○* ⁶	×	×	
	Light-gray + Clean-room pkg	Light-gray	Light-gray		Std. option	○	○	○	×	×		
Tube Fitting Stainless SUS304 Series	—	Black	Dark-blue	FKM	Turbin oil	With seal coat	×	Std. spec.	×	○* ⁷	×	×
Tube Fitting Stainless SUS303 Equivalent Corrosivity Series	—	Black	Dark-blue	HNBR	Turbin oil	With seal coat	○	○	○* ⁷	○* ⁷	×	○
Tube Fitting EG Series	—	Black	Black	NBR	Turbin oil	With seal coat	×	○	○* ⁸	×	×	○
Tube Fitting Brass Series	—	—	—	HNBR / FM / NBR	Turbin oil	With seal coat	×	Std. option	○	○	×	○
Tube Fitting Long Type	—	—	Black	NBR	Turbin oil	With seal coat	×	○* ⁵	○	○	○	○
Speed Controller Series	—	Black	Black	NBR	Turbin oil	With seal coat	—	○* ⁵	×	×	○	○
	Light-gray	Light-gray	Light-gray				Std. option	○	×	×	×	○
	Clean-room pkg	Light-gray	Light-blue		Fluorochemical grease	—	○	×	×	×	×	
	Light-gray + Clean-room pkg	Light-gray	Light-gray		Std. option	○	×	×	×	×		
Speed Controller SUS303 Equivalent Corrosivity	—	Black	Dark-blue	HNBR	Turbin oil	With seal coat	○	○	×	×	×	○
Throttle (Needle) Valve Standard Series	—	Black	Black	NBR	Turbin oil	With seal coat	—	○* ⁵	×	×	○	○
	Light-gray	Light-gray	Light-gray				Std. option	○	×	×	×	○
	Clean-room pkg	Light-gray	Light-blue		Fluorochemical grease	—	○	×	×	×	×	
	Light-gray + Clean-room pkg	Light-gray	Light-gray		Std. option	○	×	×	×	×		
Fixed Orifice Joint Series	—	Black	Black	NBR	Turbin oil	With seal coat	○	○	○	○	○* ⁹	○
Regulator Series (RVC, RVS, RVU, RVCU, RVUM)	—	Black	Black	NBR	Turbin oil	With seal coat	○	×	×	×	○* ⁹	○
Check Valve Series	—	Black	Black	NBR	Turbin oil	With seal coat	○* ¹⁰	×	×	×	○* ⁹	○
Check Valve Series (Resin Type)	—	Light-gray	Light-gray	NBR	Turbin oil	With seal coat	Std. option	×	×	×	×	○

※ 1. W: Release-ring color is light-gray

※ 2. Seal option non-purple is not available with seal rubber material FKM

※ 3. EPDM: All oil-free. Release-ring color is yellow. Thread size M3, M6 and Fitting with inch sized Tube dia are not available.

※ 4. Release-ring color: Yellow.

※ 5. Release-ring color: Brown.

※ 6. Release-ring color: Light-blue.

※ 7. Release-ring color: Dark-blue.

※ 8. Release-ring color: Black

※ 9. Release-ring Red is not selectable with body color Light-gray.

※ 10. Not available for CVU4-4, CVU6-6 and CVU8-8.

※ Contact the nearest sales office for other special specifications.

















FITTING
CONTROLLER
VALVE
TUBE

MAKE-TO-ORDER PRODUCTS

■ Reference chart of Appearance Color Combination (For Fitting)

Series	Resin color or Option	Tube dia.		Seal rubber material		Lubrication	Release-ring color	
				-F FKM	-E EPDM	-D Oil-free	-R Red	
Tube Fitting Standard Series Tube Fitting Mini Series	-	mm size						
		inch size						
	Light-gray	mm size						
		inch size						
	Clean-room pkg	mm size						
		inch size						
	Light-gray + Clean-room pkg	mm size						
		inch size						
	Tube Fitting Stainless SUS304 Series	-	mm size		Std. spec.			
	Tube Fitting Stainless SUS303 Equivalent Corrosivity Series	-	mm size					
		Light-gray	mm size					

Reference chart of Appearance Color Combination (For Controller)

Series	Resin color or Option	Tube dia.		Seal rubber material		Release-ring color
				-F FKM	-R レッド	
Speed Controller Series Throttle (Needle) Valve Standard Series	-	mm size				
		inch size				
	Light-gray	mm size				
		inch size				
	Clean-room pkg	mm size				
		inch size				
	Light-gray + Clean-room pkg	mm size				
		inch size				

※ Contact the nearest sales office for other special specifications.

Space-Saving Options

Characteristics

- Suitable for Installing in Limited Spaces.

Model Designation (Example)

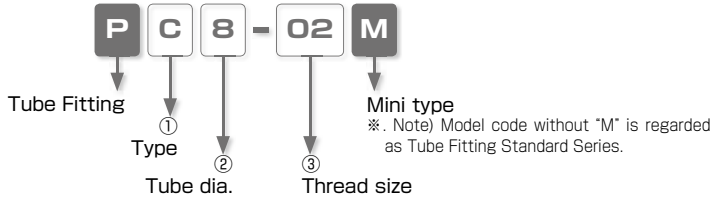

① Type

Code	Type	Code	Type	Code	Type
L	Elbow	B	Branch Tee	D	Run Tee

② Tube dia.

Code	8	10
Size (mm)	ø8	ø10

③ Thread size

Thread size	Taper pipe thread		
Code	01	02	03
Size	R1/8	R1/4	R3/8

Make-to-order products

FITTING
CONTROLLER
VALVE
TUBE

PL
Mini

Elbow

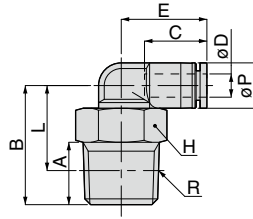

Unit : mm

Model code	Tube O.D. ϕD	R	A	B	Tube end C	L	Hex. H	E	ϕP	Weight (g)
PL8-01M	8	R1/8	8	22.5	18.1	18.5	12	21.9	15	11.9
PL8-02M		R1/4	11	25.5		19.5	14			17.5
PL8-03M		R3/8	12	26.5		20.2	17			27.9
PL10-02M	10	R1/4	11	27	20.2	21	14	24.4	18	20.9
PL10-03M		R3/8	12	28		21.7	17			28.8

※ . "L" is a reference value for height dimension after tightening thread.

MAKE-TO-ORDER
PRODUCTS

761

PB
Mini

Branch Tee

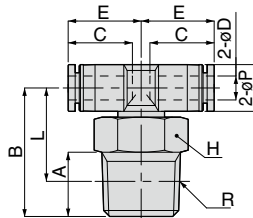

Unit : mm

Model code	Tube O.D. ϕD	R	A	B	Tube end C	L	Hex. H	E	ϕP	Weight (g)
PB8-01M	8	R1/8	8	22.5	18.1	18.5	12	21.9	15	12.8
PB8-02M		R1/4	11	25.5		19.5	14			18.2
PB8-03M		R3/8	12	26.5		20.2	17			26.1
PB10-02M	10	R1/4	11	27	20.2	21	14	24.4	18	22.3
PB10-03M		R3/8	12	28		21.7	17			30.4

※ . "L" is a reference value for height dimension after tightening thread.

PD Mini Run Tee

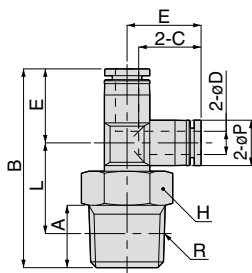

Unit : mm

Model code	Tube O.D. øD	R	A	B	Tube end C	L	Hex. H	E	øP	Weight (g)
PD8-01M	8	R1/8	8	44.2	18.1	18.5	12	21.7	15	11.9
PD8-02M		R1/4	11	47.2		19.5	14			17.5
PD8-03M		R3/8	12	48.2		20.2	17			25.3
PD10-02M	10	R1/4	11	52.3	20.2	21	14	25.3	18	21
PD10-03M		R3/8	12	53.3		21.7	17			28.8

※ .L" is a reference value for height dimension after tightening thread.