

**i** Looking for fittings that can be used with water and liquid?

**SUS303 like Corrosivity type** are newly added to Tube Fitting PP series, which can be used with water and liquid. You can save cost up to 30%.



- PP resin material, suitable for clean environment, is adopted.
- No exposure of metal on liquid contact parts (Thread : PP type only)

### Model designation (Example)

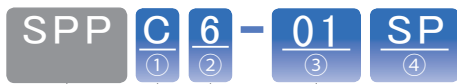

④. Thread material

Code	No code	SP
Material	PP	Special stainless (※1) or SUS303

- ※1. The corrosive resistance is equivalent to SUS303.
- ※2. No Sealock coating or Seal tape on a thread.

③. Thread size (R)

Code	Metric thread		Taper pipe thread			
	M3	M5	01	02	03	04
Size	M3×0.5	M5×0.8	R1/8	R1/4	R3/8	R1/2

※In case that ③ indicates tube dia., select tube dia. from table ②.

②. Tube dia. (øD)

Code	mm size				
	4	6	8	10	12
Tube O.D. (mm)	ø4	ø6	ø8	ø10	ø12

①. Type

Code	Type	Code	Type	Code	Type
C	Straight	L	Elbow	B	Branch Tee
D	Run Tee	X	Branch Y	U	Union Straight
G	Unequal Union Straight	MP	Bulkhead Union	V	Union Elbow
E	Union Tee	EG	Unequal Union Tee	Y	Union Y
W	Unequal Union Y	GJ	Plug-in Reducer		

Resin made (PP : Polypropylene) Tube Fitting SUS303 like corrosivity

### Specifications

Fluid medium	Air, Water, Others (Conditional ※1)
Max. operating pressure	1.0MPa (at 0 ~ 20°C) ※2
Max. vacuum	-100kPa
Operating temp. range	0 ~ 80°C (No freezing)

- ※1. Conditions when fluid medium is water or other chemicals.
  - Surge pressure must be controlled lower than max. operating pressure when using water or liquid as a fluid medium.
  - Be sure to place Insert Ring into the tube edge when using water or liquid when using water or liquid as a fluid medium.
  - Carry out resistance evaluation for the use with chemicals or mixed gasses. The product specification is different from that of SUS304 type.
- ※2. If operating temp. exceeds 20°C, refer to the following chart "Relation of Operating Temp. & Max. Operating Pressure".

### Relation of Operating Temp. & Max. Operating Pressure

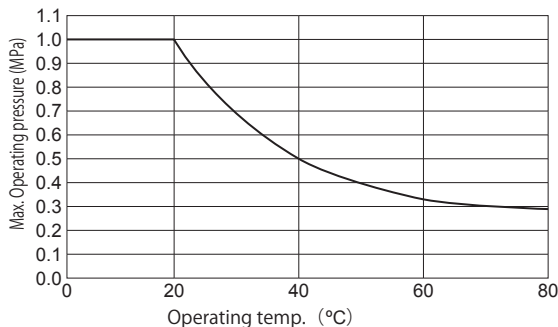

### Construction

Elbow type : SPPL (-SP)

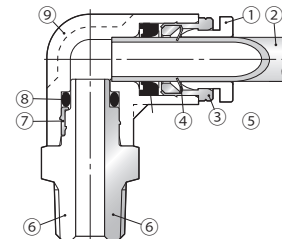

No.	Parts	Material	
		Thread body material : PP	Thread body material : Special Stainless (※1) or SUS303
①	Release ring	PP	
②	Tube	FPA, Polyolefin, Polyamide, Nylon or Polyurethane, etc.	
③	Guide ring	Special Stainless Steel (※1) or SUS303	
④	Lock claws	Stainless Steel	
⑤	Elastic sleeve	EPDM	
⑥	Thread body	PP	Special Stainless Steel (※1) or SUS303
⑦	Support ring	Special Stainless Steel (※1) or SUS303	—
⑧	O-ring	EPDM	
⑨	Fitting body	PP	

- ※1. The corrosive resistance is equivalent to SUS303.
- ※2. Material of gasket for Metric thread : (SUS304 + EPDM)

### How to identify similar products

Metal material	Parts	
	Vgroove on Guide ring	Flat groove on hexagonal-column
SUS303 like corrosivity or SUS303	No	No
SUS304	Yes	Yes

## Safety instruction manual

### ⚠ Warnings

1. Check chemical resistance before using the products, when the fluid medium is chemicals or mixed gases.  
Depending on the conditions, it may cause damage to the products, the escape of tubes, and a fluid leakage.
2. Be sure to place Insert Ring into the tube edge when using water or liquid as a fluid medium.  
There is a possibility to cause the escape of tube and a fluid leakage without Insert Ring.
3. Do not use this product under the condition with vibration or physical impact.  
These may cause damage to the products, the escape of tubes and a fluid leakage.
4. Resin can be deteriorated by being exposed to direct sunlight or ultraviolet rays.
5. Max. operating pressure varies depending on operating temperature range. Be sure to check the chart "Relation of Operating Temp. & Max. Operating Pressure" and use the products within the indicated pressure range.

### ⚠ Cautions

1. The seal rubber material EPDM is not suitable for general air piping, due to its inferior durability against mineral oil.
2. When coating the thread with seal tape or sealant, do not coat 1.5 to 2 screw ridges from the tip of the thread.
3. Tighten taper thread by hand until it stops, then use a spanner to tighten it about 2 or 3 more turns.  
Excessive tightening may break the thread part. Inadequate tightening may cause a loosened thread or a fluid leakage.
4. Resin type thread may have a fluid leakage or get loosened caused by "creep phenomena", due to a long term use of the thread.  
Check the tightening condition periodically and re-torque the thread in case of leaks.  
If re-torque of the thread does not solve a leakage problem, change it to a new product.
5. Take safety measures such as providing a protection cover if there is a risk of causing damages or fire on machine / facilities by a fluid leakage.
6. Tube insertion into this product is tighter than that of Tube Fitting Standard Series due to its oil-free specification. Make sure to insert tube up to tube end. When inserting a tube, put a liquid like water on the tube, which does not affect the product and the tube. It will improve the smoothness of tube insertion.
7. Tighten a bulkhead nut of Bulkhead Union (SPPMP) type with tightening torque shown in the table below. It may cause a fluid leakage by "creep phenomena" due to a long term use of the resin thread. Check the tightening condition periodically and re-torque the thread in case of leaks. If re-torque of the thread does not solve a leakage problem, change it to a new product.

Table. Tightening torque for bulkhead nut

Model code	Thread size	Tightening torque
SPPMP4	M12×1.5	0.5~0.7N·m
SPPMP6	M14×1.5	0.7~0.9N·m
SPPMP8	M16×1.5	0.8~1.0N·m
SPPMP10	M20×2	1.5~1.9N·m
SPPMP12	M24×2	2.2~2.8N·m

8. The level of corrosion and dust emission from the fittings varies by operating conditions. In case there is a possibility of negative effects on machines or facilities due to these conditions, evaluate the suitability of the products in advance.

## Appearance drawing

**SPPC-SP** Straight Thread material : Special Stainless Steel or SUS303

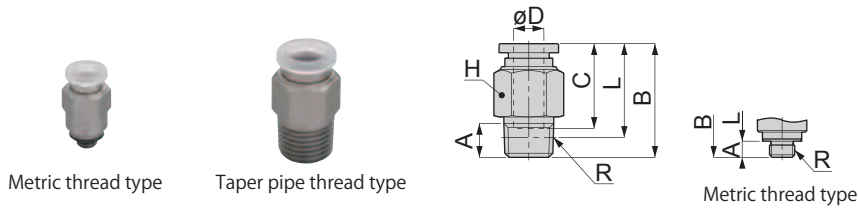

Unit : mm

Model code	Tube O.D. $\phi D$	R	A	B	L	Tube end C	Hex. H	Weight (g)	Orifice bore ( $\phi$ mm)		
SPPC4-M3SP	4	M3×0.5	2.5	20.1	17.6	14.9	10	5.5	1.2		
SPPC4-M5SP		M5×0.8	3	20	17				1.8		
SPPC4-01SP		R1/8	8	21	15			14	7.5	3	
SPPC4-02SP		R1/4	11								
SPPC6-M5SP	6	M5×0.8	3	22.1	19.1	17	12	8.3	1.8		
SPPC6-01SP		R1/8	8	22.6	18.6					14	8.4
SPPC6-02SP		R1/4	11	24.6	18.5			17	16		
SPPC6-03SP		R3/8	12	23.6	17.2						
SPPC8-01SP	8	R1/8	8	27.9	23.9	18.2	14	14	6		
SPPC8-02SP		R1/4	11	26.6	20.6				17	21	7
SPPC8-03SP		R3/8	12	23.9	17.6						
SPPC10-02SP	10	R1/4	11	29.8	23.8	20.7	17	18	8.5		
SPPC10-03SP		R3/8	12	29.3	23			24			
SPPC12-03SP	12	R3/8	12	31.9	25.6	23.3	21	32	11		
SPPC12-04SP		R1/2	15	33.9	25.7			46			

※ "L" is a reference value for height dimension after tightening a taper pipe thread.

**SPPL-SP** Elbow Thread material : Special Stainless Steel or SUS303

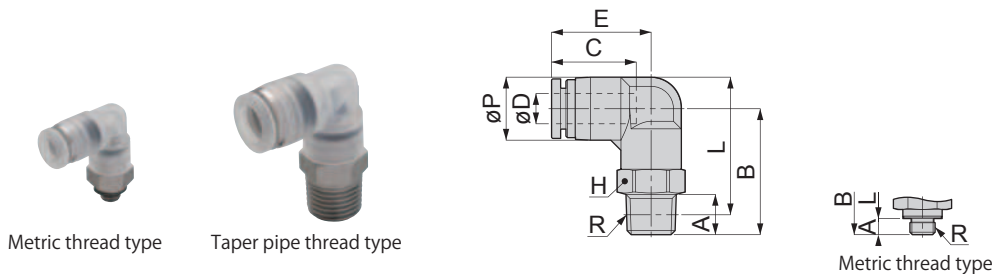

Unit : mm

Model code	Tube O.D. $\phi D$	R	A	B	L	$\phi P$	Tube end C	E	Hex. H	Weight (g)	Orifice bore ( $\phi$ mm)		
SPPL4-M3SP	4	M3×0.5	2.5	19.8	22.3	10	14.9	18	10	6	1.2		
SPPL4-M5SP		M5×0.8	3	20.3						6.9	1.8		
SPPL4-01SP		R1/8	8	23.3	24.3					14	18	9.5	2.8
SPPL4-02SP		R1/4	11	26.3	25.3								
SPPL6-M5SP	6	M5×0.8	3	22	25.3	12.5	16.8	19.8	12	11	1.8		
SPPL6-01SP		R1/8	8	25	27.3					14	19	13	4.6
SPPL6-02SP		R1/4	11	28	28.2								
SPPL6-03SP		R3/8	12	29.8	29.7								
SPPL8-01SP	8	R1/8	8	28	31.3	14.5	18.1	22.7	14	16	6		
SPPL8-02SP		R1/4	11	31	32.2					17		33	
SPPL8-03SP		R3/8	12	32.8	33.7								
SPPL10-02SP	10	R1/4	11	36	38.7	17.5	20.2	26.2	17	30	8		
SPPL10-03SP		R3/8	12	37	39.4					37			
SPPL12-03SP	12	R3/8	12	39	43.2	21	23.4	29.4	21	46	10		
SPPL12-04SP		R1/2	15	42	44.3					60			

※ "L" is a reference value for height dimension after tightening a taper pipe thread.

**SPPB-SP** Branch Tee Thread material : Special Stainless Steel or SUS303

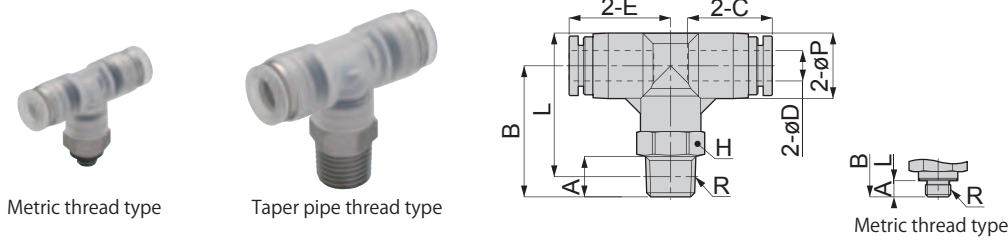

Unit : mm

Model code	Tube O.D. øD	R	A	B	L	øP	Tube end C	E	Hex. H	Weight (g)	Orifice bore (ømm)
SPPB4-M3SP	4	M3×0.5	2.5	19.7	22.2	10	14.9	16.9	10	7.9	1.2
SPPB4-M5SP		M5×0.8	3	20.2						8.8	1.8
SPPB4-01SP		R1/8	8	23.2	24.2			12	2.8		
SPPB4-02SP		R1/4	11	26.2	25.2			14		20	
SPPB6-M5SP	6	M5×0.8	3	23	26.5	13	17	20.15	12	14	1.8
SPPB6-01SP		R1/8	8	26	28.5					16	4.6
SPPB6-02SP		R1/4	11	29	29.5				14	22	
SPPB6-03SP		R3/8	12	30.8	31				17	34	
SPPB8-01SP	8	R1/8	8	26.3	29.8	15	18.1	22.4	14	20	5.8
SPPB8-02SP		R1/4	11	29.3	30.8					25	
SPPB8-03SP		R3/8	12	31.1	32.3				17	37	
SPPB10-02SP	10	R1/4	11	36	38.7	17.5	20.2	25.2	17	36	8
SPPB10-03SP		R3/8	12	37	39.4					43	
SPPB12-03SP	12	R3/8	12	39	43.2	21	22.9	28.4	21	54	10
SPPB12-04SP		R1/2	15	42	44.3					69	

※ "L" is a reference value for height dimension after tightening a taper thread.

**SPPD-SP** Run Tee Thread material : Special Stainless Steel or SUS303

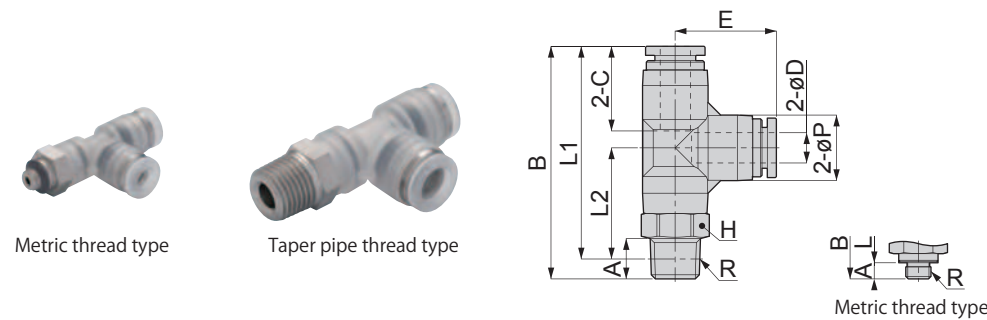

Unit : mm

Model code	Tube O.D. øD	R	A	B	L1	L2	øP	Tube end C	E	Hex. H	Weight (g)	Orifice bore (ømm)
SPPD4-M3SP	4	M3×0.5	2.5	36.6	34.1	17.2	10	14.9	16.9	10	7.9	1.2
SPPD4-M5SP		M5×0.8	3	37.1							8.8	1.8
SPPD4-01SP		R1/8	8	40.1	36.1	19.2			12	2.8		
SPPD4-02SP		R1/4	11	43.1	37.1	20.2			14		20	
SPPD6-M5SP	6	M5×0.8	3	43.2	40.2	20	13	17	20.1	12	14	1.8
SPPD6-01SP		R1/8	8	46.2	42.2	22					16	4.6
SPPD6-02SP		R1/4	11	49.2	43.1	23				14	22	
SPPD6-03SP		R3/8	12	51	44.6	24.5				17	34	
SPPD8-01SP	8	R1/8	8	50.4	46.4	24.2	15	18.1	22.2	14	20	6
SPPD8-02SP		R1/4	11	53.4	47.4	25.2					25	
SPPD8-03SP		R3/8	12	55.2	48.9	26.7				17	37	
SPPD10-02SP	10	R1/4	11	61.2	55.2	30	17.5	20.2	25.2	17	36	8
SPPD10-03SP		R3/8	12	62.2	55.9	30.7					43	
SPPD12-03SP	12	R3/8	12	67.6	61.3	32.9	21	22.9	28.2	21	54	10
SPPD12-04SP		R1/2	15	70.6	62.4	34					69	

※ "L1" and "L2" are reference values for height dimensions after tightening a taper thread.



**SPPX-SP** Branch Y Thread material : Special Stainless Steel or SUS303



Metric thread type



Taper pipe thread type

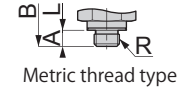
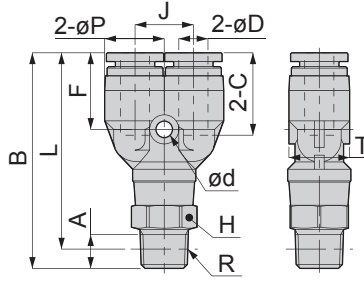

Metric thread type

Unit : mm

Model code	Tube O.D. øD	R	A	B	L	øP	Tube end C	J	ød	F	Hex. H	T	Weight (g)	Orifice bore (ømm)
SPPX4-M3SP	4	M3×0.5	2.5	37.1	34.6	10	14.9	11	3.2	14.1	10	10.4	8.2	1.2
SPPX4-M5SP		M5×0.8	3	37.6									9.1	1.8
SPPX4-01SP		R1/8	8	40.6	36.6						12		2.6	
SPPX4-02SP		R1/4	11	43.6	37.6						21			
SPPX6-M5SP	6	M5×0.8	3	41.4	38.4	12.5	17	12	3.4	15.8	12	13.5	14	1.8
SPPX6-01SP		R1/8	8	44.4	40.4								16	4.2
SPPX6-02SP		R1/4	11	47.4	41.3						23			
SPPX6-03SP		R3/8	12	49.2	42.8						35			
SPPX8-01SP	8	R1/8	8	48.7	44.7	14.5	18.1	14	3.4	17.2	14	15.1	20	5.9
SPPX8-02SP		R1/4	11	51.7	45.7								25	
SPPX8-03SP		R3/8	12	53.5	47.2						37			
SPPX10-02SP	10	R1/4	11	58.3	52.3	18	20.7	18	4.5	19.5	17	18	37	6.7
SPPX10-03SP		R3/8	12	59.3	53								45	
SPPX12-03SP	12	R3/8	12	64.5	58.2	21	23.4	20	4.2	22.2	21	21	56	7.9
SPPX12-04SP		R1/2	15	67.5	59.3								71	

※"L" is a reference value for height dimension after tightening a taper pipe thread.

**SPPC** Straight Thread material : PP

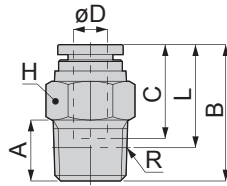

Unit : mm

Model code	Tube O.D. øD	R	A	B	L	Tube end C	Hex. H	Weight (g)	Orifice bore (ømm)
SPPC4-01	4	R1/8	8	21	17	14.9	12	2.7	2.5
SPPC4-02		R1/4	11	22.2	16.2		14	3.5	
SPPC6-01	6	R1/8	8	22.7	18.7	17	14	3.3	4
SPPC6-02		R1/4	11	24.7	18.6			3.8	
SPPC6-03		R3/8	12	24.8	18.4		5.1		
SPPC8-01	8	R1/8	8	27.9	23.9	18.2	17	5.2	6
SPPC8-02		R1/4	11	26.6	20.6			6	
SPPC8-03		R3/8	12	27.5	21.2			6	
SPPC10-02	10	R1/4	11	32.4	26.4	20.2	19	8.2	7.5
SPPC10-03		R3/8	12	33.4	27.1			9.2	
SPPC12-03	12	R3/8	12	37.4	31.1	23.4	22	13	9
SPPC12-04		R1/2	15	33.9	25.7				

※"L" is a reference value for height dimension after tightening a taper pipe thread.

**SPPL** Elbow Thread material : PP

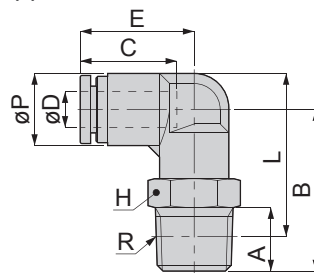

Unit : mm

Model code	Tube O.D. øD	R	A	B	L	øP	Tube end C	E	Hex. H	Weight (g)	Orifice bore (ømm)
SPPL4-01	4	R1/8	8	23.3	24.3	10	14.9	18	10	3.7	2.5
SPPL4-02		R1/4	11	26.3	25.3				14	4.5	
SPPL6-01	6	R1/8	8	25	27.3	12.5	16.8	19.8	12	4.4	4
SPPL6-02		R1/4	11	28	28.2				14	5.6	
SPPL6-03		R3/8	12	29.8	29.7				17	6.4	
SPPL8-01	8	R1/8	8	28	31.3	14.5	18.1	22.7	14	6.8	6
SPPL8-02		R1/4	11	31	32.2				17	7.4	
SPPL8-03		R3/8	12	32.8	33.7				17	8.2	
SPPL10-02	10	R1/4	11	36	38.7	17.5	20.2	26.2	17	12	7.5
SPPL10-03		R3/8	12	37	39.4				17	13	
SPPL12-03	12	R3/8	12	39	43.2	21	23.4	29.4	22	18	9
SPPL12-04		R1/2	15	42	44.3				22	20	

※ "L" is a reference value for height dimension after tightening a taper pipe thread.

**SPPB** Branch Tee Thread material : PP

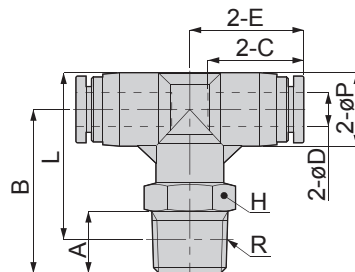

Unit : mm

Model code	Tube O.D. øD	R	A	B	L	øP	Tube end C	E	Hex. H	Weight (g)	Orifice bore (ømm)
SPPB4-01	4	R1/8	8	23.2	24.2	10	14.9	16.9	10	5.6	2.5
SPPB4-02		R1/4	11	26.2	25.2				14	6.3	
SPPB6-01	6	R1/8	8	26	28.5	13	17	20.15	12	7.8	4
SPPB6-02		R1/4	11	29	29.5				14	8.6	
SPPB6-03		R3/8	12	30.8	31				17	9.4	
SPPB8-01	8	R1/8	8	26.3	29.8	15	18.1	22.4	14	11	5.8
SPPB8-02		R1/4	11	29.3	30.8				17	12	
SPPB8-03		R3/8	12	31.1	32.3				17	13	
SPPB10-02	10	R1/4	11	36	38.7	17.5	20.2	25.2	17	18	7.5
SPPB10-03		R3/8	12	37	39.4				17	19	
SPPB12-03	12	R3/8	12	39	43.2	21	22.9	28.4	22	27	9
SPPB12-04		R1/2	15	42	44.3				22	28	

※ "L" is a reference value for height dimension after tightening a taper pipe thread.

**SPPD** Run Tee Thread material : PP

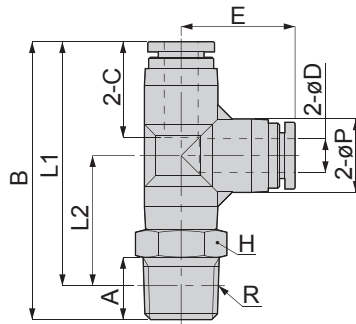

Unit : mm

Model code	Tube O.D. øD	R	A	B	L1	L2	øP	Tube end C	E	Hex. H	Weight (g)	Orifice bore (ømm)
SPPD4-01	4	R1/8	8	40.1	36.1	19.2	10	14.9	16.9	10	5.6	2.5
SPPD4-02		R1/4	11	43.1	37.1	20.2				14	6.3	
SPPD6-01	6	R1/8	8	46.2	42.2	22	13	17	20.1	12	7.8	4
SPPD6-02		R1/4	11	49.2	43.1	23				14	8.5	
SPPD6-03		R3/8	12	51	44.6	24.5				17	9.3	
SPPD8-01	8	R1/8	8	50.4	46.4	24.2	15	18.1	22.2	14	11	6
SPPD8-02		R1/4	11	53.4	47.4	25.2				14	12	
SPPD8-03		R3/8	12	55.2	48.9	26.7				17	13	
SPPD10-02	10	R1/4	11	61.2	55.2	30	17.5	20.2	25.2	17	18	7.5
SPPD10-03		R3/8	12	62.2	55.9	30.7				17	19	
SPPD12-03	12	R3/8	12	67.6	61.3	32.9	21	22.9	28.2	22	27	9
SPPD12-04		R1/2	15	70.6	62.4	34				22	28	

※ "L1" and "L2" are values for height dimensions after tightening a taper pipe thread.

**SPPX** Branch Y Thread material : PP

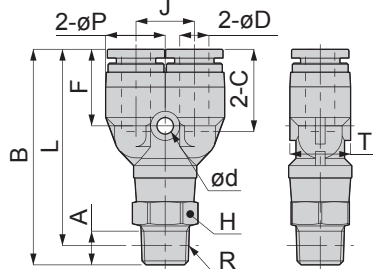

Unit : mm

Model code	Tube O.D. øD	R	A	B	L	øP	Tube end C	J	ød	F	Hex. H	T	Weight (g)	Orifice bore (ømm)
SPPX4-01	4	R1/8	8	40.6	36.6	10	14.9	11	3.2	14.1	10	10.4	5.9	2.5
SPPX4-02		R1/4	11	43.6	37.6						14		6.7	
SPPX6-01	6	R1/8	8	44.4	40.4	12.5	17	12	3.4	15.8	12	13.5	8	4
SPPX6-02		R1/4	11	47.4	41.3						14		8.7	
SPPX6-03		R3/8	12	49.2	42.8						17		9.5	
SPPX8-01	8	R1/8	8	48.7	44.7	14.5	18.1	14	3.4	17.2	14	15.1	12	5.9
SPPX8-02		R1/4	11	51.7	45.7						14		13	
SPPX8-03		R3/8	12	53.5	47.2						17		13	
SPPX10-02	10	R1/4	11	58.3	52.3	18	20.7	18	4.5	19.5	17	18	20	6.7
SPPX10-03		R3/8	12	59.3	53						17		21	
SPPX12-03	12	R3/8	12	64.5	58.2	21	23.4	20	4.2	22.2	22	21	29	7.9
SPPX12-04		R1/2	15	67.5	59.3						22		30	

※ "L" is a reference value for height after tightening a taper pipe thread.



**SPPU** Union Straight

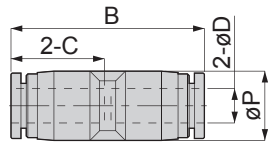

Unit : mm

Model code	Tube O.D. øD	Tube end C	B	øP	Weight (g)	Orifice bore (ømm)
SPPU4	4	14.9	30.8	10	4	2.8
SPPU6	6	17	34.9	12.5	5.4	4.3
SPPU8	8	18.1	37.8	14.5	7.8	7
SPPU10	10	20.2	41.4	17.5	13	9
SPPU12	12	23.4	47.8	21	19	11

**SPPG** Unequal Union Straight

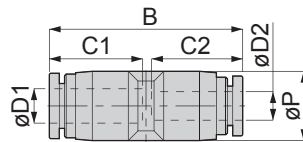

Unit : mm

Model code	Tube O.D. øD1	Tube O.D. øD2	Tube end C1	Tube end C2	B	øP	Weight (g)	Orifice bore (ømm)
SPPG6-4	6	4	17	14.9	34.4	12.5	5.2	2.8
SPPG8-6	8	6	18.1	17	37.9	14.5	7.2	4.3
SPPG10-8	10	8	20.2	18.1	41.1	17.5	11	6.5
SPPG12-10	12	10	23.4	20.2	47.6	21	19	9

**SPPV** Union Elbow

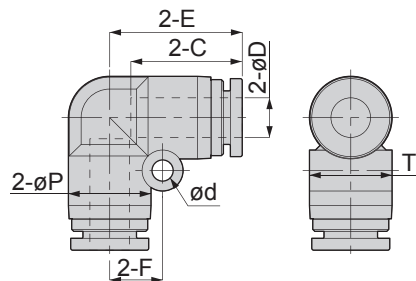

Unit : mm

Model code	Tube O.D. øD	øP	Tube end C	E	ød	T	F	Weight (g)	Orifice bore (ømm)
SPPV4	4	10	14.9	16.9	3.2	10.4	6.5	4.8	2.8
SPPV6	6	12.5	17	20.1	3.2	13.5	8	6.6	5
SPPV8	8	15	18.1	22.4	4.2	15.6	10	8.9	7.2
SPPV10	10	17.5	20.2	26.2	4.2	18.2	12	14	8.3
SPPV12	12	21	23.4	29.4	4.2	21.7	14	20	10

**SPPE** Union Tee

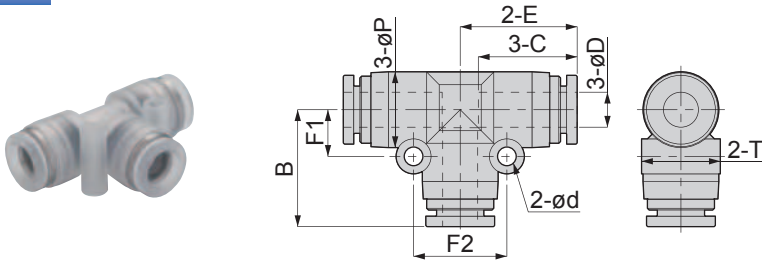

Unit : mm

Model code	Tube O.D. øD	øP	Tube end C	E	B	ød	T	F1	F2	Weight (g)	Orifice bore (ømm)
SPPE4	4	10	14.9	17.2	17.2	3.2	10.4	6.5	13	6.4	2.8
SPPE6	6	13	17	20.05	20.1	3.2	13.5	8	16	8.9	4.8
SPPE8	8	15	18.1	22.2	22.2	3.2	15.6	9	18	13	6.2
SPPE10	10	17.5	20.2	25.2	25.2	4.2	18.2	12	24	21	8.1
SPPE12	12	21	22.9	28.4	28.2	4.2	21.7	14	28	30	10

**SPPEG** Unequal Union Tee

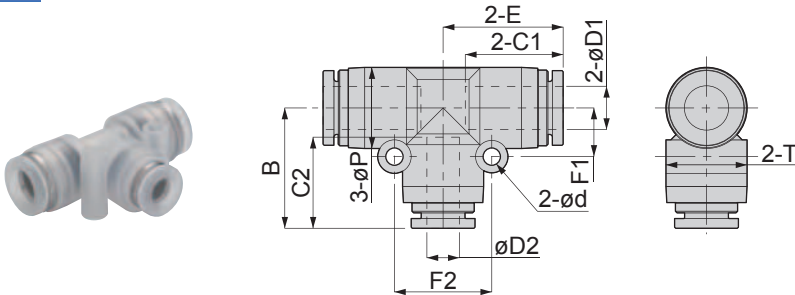

Unit : mm

Model code	Tube O.D. øD1	Tube O.D. øD2	øP	Tube end C1	Tube end C2	E	B	ød	F1	F2	T	Weight (g)	Orifice bore (ømm)
SPPEG6-4	6	4	13	17	14.9	20.05	19.5	3.2	8	16	13.5	8.7	2.8
SPPEG8-6	8	6	15	18.1	17	22.2	22.3	3.2	9	18	15.6	13	4.3
SPPEG10-8	10	8	17.5	20.2	18.1	25.2	24.9	4.2	12	24	18.2	19	6.2
SPPEG12-10	12	10	21	22.9	20.7	28.4	28	4.2	14	28	21.7	29	8.1

**SPPY** Union Y

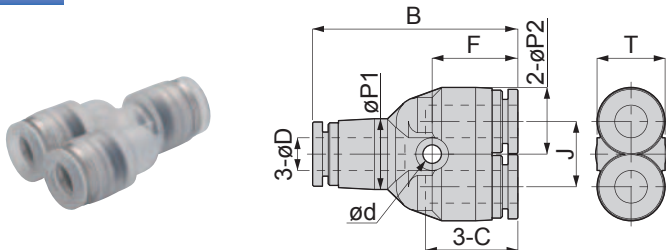

Unit : mm

Model code	Tube O.D. øD	B	øP1	øP2	Tube end C	J	ød	F	T	Weight (g)	Orifice bore (ømm)
SPPY4	4	32.8	10	10	14.9	11	3.2	14.1	10.4	6.3	2.6
SPPY6	6	37.7	13	12.5	17	12	3.4	15.8	13.5	8.6	4.3
SPPY8	8	42.4	15	14.5	18.1	14	3.4	17.2	15.1	13	5.7
SPPY10	10	48.4	17.5	17.5	20.7	18	4.2	19.5	18.2	21	6.7
SPPY12	12	54.8	21	21	23.4	20	4.2	22.2	21.7	30	8

**SPPW** Unequal Union Y

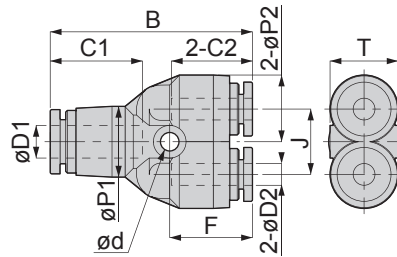

Unit : mm

Model code	Tube O.D. øD1	Tube O.D. øD2	B	øP1	øP2	Tube end C1	Tube end C2	J	ød	T	F	Weight (g)	Orifice bore (ømm)
SPPW6-4	6	4	37.2	13	12.5	17	14.9	12	3.4	13.5	15.2	8.3	3.7
SPPW8-6	8	6	42.5	14.5	12.5	18.1	17	14	3.4	15.1	17.3	11	5
SPPW10-8	10	8	48.1	17.5	14.5	20.2	18.1	18	4.5	18.2	19.2	16	6.5
SPPW12-10	12	10	54.6	21	17.5	23.4	20.2	20	4.5	21.7	22	25	7.8

**SPPMP** Bulkhead Union

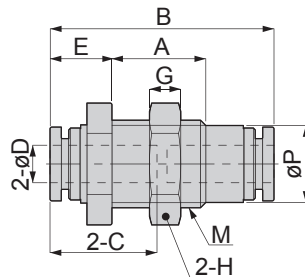

Unit : mm

Model code	Tube O.D. øD	M	B	E	A	øP	Tube end C	Hex. H	G	Weight (g)	Orifice bore (ømm)
SPPMP4	4	M12×1.5	31.4	9.2	12	10	14.9	14	5	7.2	3
SPPMP6	6	M14×1.5	35.5	9.8	15	12.3	17	17	5	11	4.9
SPPMP8	8	M16×1.5	38.4	10.7	15.5	14.2	18.1	19	6	15	7
SPPMP10	10	M20×2	43	13	18.5	17.5	20.7	24	6	25	8
SPPMP12	12	M20×2	48.4	13.2	20.5	21	23.4	27	6	31	11

**SPPGJ** Plug-in Reducer

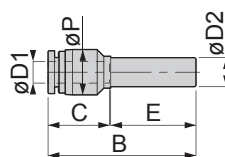

Unit : mm

Model code	Tube O.D. øD1	Tube dia. øD2	B	E	øP	Tube end C	Weight (g)	Orifice bore (ømm)
SPPGJ6-4	4	6	37.7	22.3	10	14.9	2.4	2.8
SPPGJ8-4	4	8	40.2	23.3	12.5	14.9	3	2.8
SPPGJ8-6	6		40.8			17	3.3	4.3
SPPGJ10-6	6	10	43.8	28.3	12.5	17	3.7	4.3
SPPGJ10-8	8		43.7			24.8	14.5	18.1
SPPGJ12-8	8	12	49.7	33.5	14.5	18.1	5.4	6.1
SPPGJ12-10	10		50			28.8	17.5	20.2

# Tube Fitting PP Series Conventional type

Metal material  
**SUS304**

- Push-in fitting for clean environment that can be used with water and liquid. No metal exposure on liquid contact part. (Thread material : PP type only)
- PP (polypropylen) for the body material, suitable for clean environment. Semitransparent resin body enables to see the fluid (liquid) inside.
- Oil-free Spec. for various industries.
- Seal rubber material, Packaging and washing spec. are selectable.

Thread material : PP

Tube dia. (øD) : ø4(ø5/32), ø6, ø8(ø5/16), ø10, ø12mm, ø1/4, ø3/8, ø1/2in. Thread size (R) : R1/8, R1/4, R3/8, R1/2



Thread material : SUS304

Tube dia. (øD) : ø4(ø5/32), ø6, ø8(ø5/16), ø10, ø12mm, ø1/4, ø3/8, ø1/2in. Thread size (R) : M3, M5, R1/8, R1/4, R3/8, R1/2



Union

Tube dia. (øD, øD1, øD2) : ø4(ø5/32), ø6, ø8(ø5/16), ø10, ø12mm, ø1/4, ø3/8, ø1/2in.



Others



Please visit Pisco Website for the detailed information about above-listed Tube Fitting PP series [【http://en.pisco.co.jp/product/detail/a/a09/】](http://en.pisco.co.jp/product/detail/a/a09/)

## Recommended Tubes

Please visit Pisco Website for the detailed information about below-listed Tubes [【http://en.pisco.co.jp/product/connect/tube/】](http://en.pisco.co.jp/product/connect/tube/)

- Tubes that can be used with water and liquid.
- Various selections depending on piping space and fluid.

Polyurethane Tube UB, UC	Nylon Tube NA, NB	Polyamide Tube SNT	Polyolefin Tube CTA, CTB	Fluororesin Tube SFT, SET
10 colors (UB); 6 colors (UC)	9 colors (NA), 12 colors (NB)	1 color	6 colors	1 color (SFT), 2 colors (SET)
Air, liquid	Air, liquid, heat medium oil	Air, liquid, drinking water	Air, liquid, chemicals	Air, liquid, chemicals
0.8 MPa (UB), 0.6 MPa (UC)	1.5 MPa (NA), 1.0 MPa (NB)	1.5 MPa	1.0 MPa (CTA), 0.8 MPa (CTB)	0.8~2.4 MPa (SFT), 0.7~2.7 MPa (SET)
-15~60°C	-15~90°C	-15~90°C	-15~80°C	-65~260°C (SFT), -65~200°C (SET)
Bending radius: Smaller ← UC, UB, CTB, NB, CTA, NA, SNT, SFT, SET → Larger				

※ Icons: Color, Fluid medium, Max. operating pressure, Operating temp.range

**PISCO**